



Product	Description	Part Number	Weight	List Price
---------	-------------	-------------	--------	------------

For faster billing & immediate tracking numbers, request your invoices to be emailed or faxed to you.

Also, check out our web site at www.schumacherirrigation.com

SECTION THREE

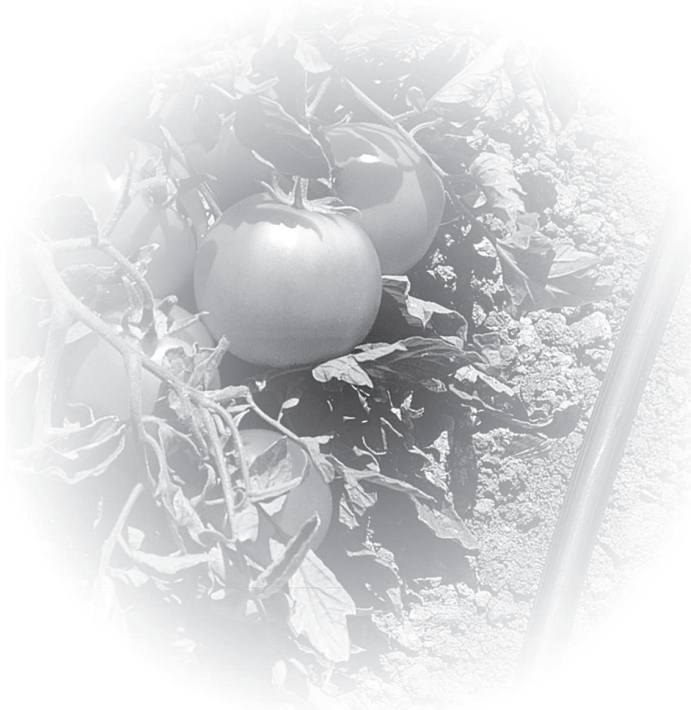

Pipe

Aluminum & PVC Sprinkler Pipe

Standard Aluminum Mainline Pipe

Tubing Corrugated Drainage Pipe

Heavy Wall Aluminum Pipe

Gated Aluminum Pipe

Poly Pipe

PVC Surface Gated Pipe

PVC Surface Accessories

PVC Underground Pipe

Gates & Gate Socks

Pipe Turners

Vacuum Pipe

NU-FLEX TUBING & SIPHPON TUBES



Product	Description	Part Number	Weight	List Price
---------	-------------	-------------	--------	------------

NU-FLEX LAYFLAT SURFACE TUBING (FOR FLOOD/FURROW IRRIGATION)



Dia	Length	Mil	MaxGPM		Wt.	
5"	500'	6	250	6-9798	19	61.00
5"	1000'	6	250	6-9799	38	122.00
5"	600'	10	250	6-9800	38	87.00
9"	1320'	5	449	6-9801	73	235.00
9"	950'	7	449	6-9802	73	235.00
9"	600'	10	449	6-9803		195.00
10"	1000'	10	598	6-9804	95	402.00
12"	1320'	5	898	6-9805	98	315.00
12"	500'	5	898	6-9806	49	102.00
12"	950'	7	898	6-9807	98	315.00
12"	1320'	7	898	6-9808	136	434.00
12"	1000'	10	898	6-9809	147	402.00
15"	1320'	5	1347	6-9810	126	402.00
15"	950'	7	1347	6-9811	126	260.00
15"	1320'	7	1347	6-9812	174	555.00
15"	1000'	10	1347	6-9813	188	442.00
18"	500'	6	1750	6-9815	68	145.00
18"	1000'	6	1750	6-9814	135	280.00
18"	850'	7	1750	6-9816	135	425.00
18"	750'	8	1750	6-9817	135	276.00
18"	600'	10	1750	6-9818	135	428.00
21"	700'	8	2200	6-9819	145	465.00
21"	600'	10	2200	6-9820	157	318.00
24"	700'	8	2650	6-9821	166	526.00

Call for other sizes, mil thicknesses and tools.

Advantages:

1. Low Cost
2. Reduced Labor Cost
3. New Product Every Season
4. Less friction loss than aluminum pipe
5. Can be used as mainline or gated pipe

Slide Gate for Surface Tubing	9-5242	3.00
-------------------------------	--------	------

ALUMINUM SIPHPON TUBES

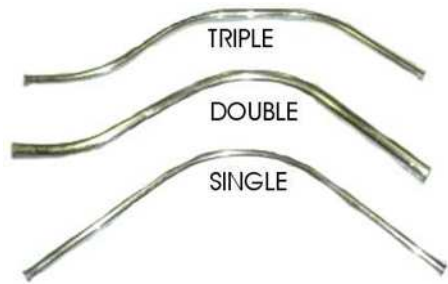

PVC Siphon tubes are also available, Call for Prices.

Size	Length	Single Bend		Double Bend		Triple Bend	
		Part #	List	Part #	List	Part #	List
1/2"	60"	9-5362	\$ 4.20	9-5379	\$ 4.20		
3/4"	54"			9-5380	\$ 4.90		
3/4"	60"	9-5363	\$ 5.40	9-5381	\$ 5.40	9-5405	\$ 5.40
3/4"	72"			9-5382	\$ 6.20	9-5406	\$ 6.20
1"	48"	9-5364	\$ 4.70				
1"	54"	9-5365	\$ 6.40	9-5383	\$ 6.40		
1"	60"	9-5366	\$ 6.70	9-5384	\$ 6.70	9-5407	\$ 6.70
1"	72"	9-5367	\$ 7.80	9-5385	\$ 7.80	9-5408	\$ 7.70
1"	90"					9-5409	\$ 10.50
1-1/4"	48"	9-5368	\$ 6.50				
1-1/4"	54"	9-5369	\$ 8.10	9-5386	\$ 8.00		
1-1/4"	60"	9-5370	\$ 10.70	9-5387	\$ 8.70	9-5410	\$ 8.70
1-1/4"	64"			9-5388	\$ 8.70		
1-1/4"	72"	9-5371	\$ 10.70	9-5389	\$ 9.70	9-5411	\$ 10.60
1-1/4"	90"					9-5412	\$ 12.20
1-1/2"	48"	9-5372	\$ 11.00				
1-1/2"	54"			9-5390	\$ 11.10		
1-1/2"	60"	9-5373	\$ 12.00	9-5391	\$ 11.90	9-5413	\$ 11.90
1-1/2"	64"			9-5392	\$ 11.80		
1-1/2"	72"	9-5374	\$ 14.00	9-5393	\$ 14.00	9-5414	\$ 14.00
1-1/2"	90"					9-5415	\$ 17.60
2"	48"	9-5375	\$ 14.00				
2"	54"			9-5394	\$ 14.90		
2"	60"	9-5376	\$ 17.10	9-5395	\$ 17.10	9-5416	\$ 17.10
2"	64"			9-5396	\$ 17.70		
2"	72"	9-5377	\$ 20.20	9-5397	\$ 20.20	9-5417	\$ 20.20
2"	90"					9-5418	\$ 25.30
3"	60"	9-5378	\$ 56.50	9-5398	\$ 56.20		
3"	72"			9-5399	\$ 73.00		
3"	90"			9-5400	\$ 86.20	9-5419	\$ 86.20
4"	72"			9-5401	\$ 96.10		
4"	96"			9-5402	\$ 121.20		
4"	120"					9-5420	\$ 161.60
5"	96"			9-5403	\$ 200.70	9-5421	\$ 200.70
5"	120"					9-5422	\$ 251.60
6"	96"			9-5404	\$ 238.60	9-5423	\$ 238.60
6"	120"					9-5424	\$ 302.00

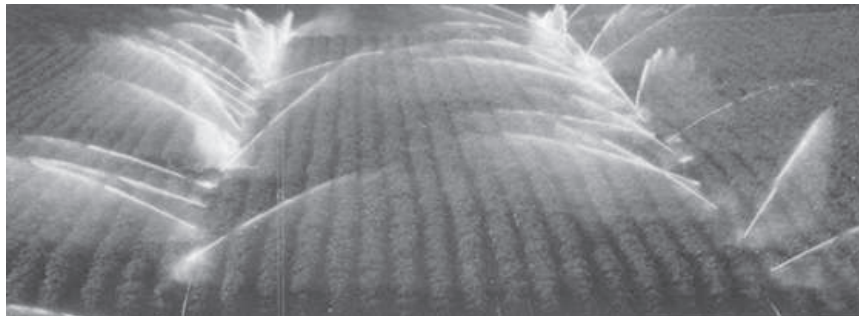

ALUMINUM

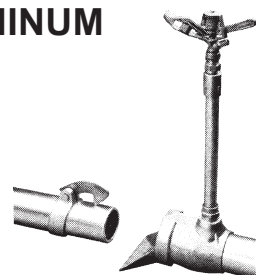

Aluminum press-on coupler with 1" riser outlet. Gasket and band & hook included. Price excludes riser and sprinkler.

2" x 20'	4-0530	.45/ft	Call
2" x 30'	4-0531	.42/ft	Call
2" x 40'	4-0532	.41/ft	Call
3" x 20'	4-0536	.65/ft	Call
3" x 30'	4-0537	.61/ft	Call
3" x 40'	4-0538	.60/ft	Call
4" x 20'	4-0533	.86/ft	Call
4" x 30'	4-0534	.82/ft	Call
4" x 40'	4-0535	.80/ft	Call

Pipe

PVC W/SPIKE COUPLER

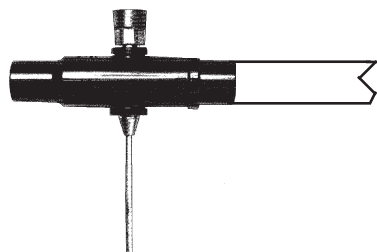

Has 3/4" riser outlet.
*See page 53 for spike couplers

2" x 30'	4-3510	--	Call
2" x 40'	4-3511	--	Call
2-1/2" x 30'	4-3512	--	Call
2-1/2" x 40'	4-3513	--	Call

PIECES/TRUCKLOAD:

	6"	8"	10"	12"
Hook & Band	255	143	90	63
Ringlock	195	120	87	63

STANDARD ALUMINUM MAINLINE PIPE



Product	Description	Part Number	Weight	List Price
PLAIN			Wall Max PSI	
	4" x 20' .050	---	4-0110	.79/ft Call
	4" x 30' .050	---	4-0111	.77/ft Call
	4" x 40' .050	---	4-0112	.76/ft Call
	6" x 10' .051	---	4-0130	1.25/ft Call
	6" x 15' .051	---	4-0131	1.20/ft Call
	6" x 20' .051	---	4-0132	1.18/ft Call
	6" x 30' .051	---	4-0133	1.15/ft Call
	6" x 40' .051	---	4-0134	1.14/ft Call
	8" x 10' .051	---	4-0160	1.73/ft Call
	8" x 15' .051	---	4-0161	1.65/ft Call
	8" x 20' .051	---	4-0162	1.62/ft Call
	8" x 30' .051	---	4-0163	1.58/ft Call
	8" x 40' .051	---	4-0164	1.56/ft Call
	10" x 10' .051	---	4-0190	2.35/ft Call
	10" x 15' .051	---	4-0191	2.20/ft Call
	10" x 20' .051	---	4-0192	2.13/ft Call
10" x 30' .051	---	4-0193	2.05/ft Call	
10" x 40' .051	---	4-0194	2.01/ft Call	

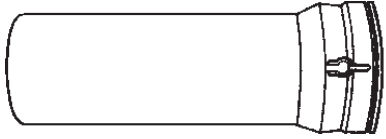

BAND & HOOK

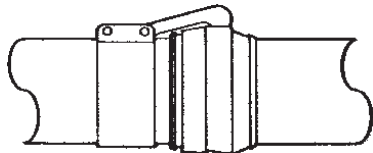

Pieces/Truckload:
 4" - 575
 6" - 255
 8" - 143
 10" - 90

4" x 20' .050	---	4-0120	.82/ft	Call
4" x 30' .050	---	4-0121	.79/ft	Call
4" x 40' .050	---	4-0122	.77/ft	Call
6" x 10' .051	100#	4-0140	1.53/ft	Call
6" x 15' .051	100#	4-0141	1.38/ft	Call
6" x 20' .051	100#	4-0142	1.31/ft	Call
6" x 30' .051	100#	4-0143	1.24/ft	Call
6" x 40' .051	100#	4-0144	1.21/ft	Call
8" x 10' .051	70#	4-0170	2.11/ft	Call
8" x 15' .051	70#	4-0171	1.90/ft	Call
8" x 20' .051	70#	4-0172	1.80/ft	Call
8" x 30' .051	70#	4-0173	1.70/ft	Call
8" x 40' .051	70#	4-0174	1.65/ft	Call
10" x 10' .051	60#	4-0195	2.80/ft	Call
10" x 15' .051	60#	4-0196	2.50/ft	Call
10" x 20' .051	60#	4-0197	2.35/ft	Call
10" x 30' .051	60#	4-0198	2.20/ft	Call
10" x 40' .051	60#	4-0199	2.13/ft	Call

RINGLOCK

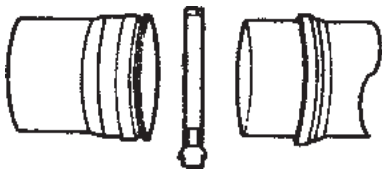

Pieces/Truckload:
 6" - 195
 8" - 120
 10" - 87

6" x 10' .051	125#	4-0150	1.81/ft	Call
6" x 15' .051	125#	4-0151	1.58/ft	Call
6" x 20' .051	125#	4-0152	1.46/ft	Call
6" x 30' .051	125#	4-0153	1.34/ft	Call
6" x 40' .051	125#	4-0154	1.28/ft	Call
8" x 10' .051	90#	4-0180	2.48/ft	Call
8" x 15' .051	90#	4-0181	2.15/ft	Call
8" x 20' .051	90#	4-0182	1.99/ft	Call
8" x 30' .051	90#	4-0183	1.83/ft	Call
8" x 40' .051	90#	4-0184	1.75/ft	Call
10" x 10' .051	70#	4-0185	3.29/ft	Call
10" x 15' .051	70#	4-0186	2.83/ft	Call
10" x 20' .051	70#	4-0187	2.59/ft	Call
10" x 30' .051	70#	4-0188	2.36/ft	Call
10" x 40' .051	70#	4-0189	2.25/ft	Call

STEEL TUBING



Diameter	Gauge	Wall Thickness			
2"	11 ga.	.125	4-0507	2.4/ft	3.00/ft
2-1/2"	11 ga.	.125	4-0508	3.0/ft	4.00/ft
3"	14 ga.	.083	4-0509	2.4/ft	4.50/ft
4"	14 ga.	.083	9-5146	3.2/ft	4.20/ft
4"	12 ga.	.105	4-0510	4.5/ft	6.00/ft
4"	11 ga.	.125	9-5145	4.9/ft	5.50/ft
4"	10 ga.	.135	9-5137	5.7/ft	7.00/ft
4"	10 ga. SS #304	.135	9-5161	5.7/ft	51.00/ft
5"	12 ga.	.105	4-0511	5.6/ft	7.75/ft
5"	11 ga.	.125	9-5142	6.4/ft	6.00/ft
5"	10 ga.	.135	9-5141	7.2/ft	7.00/ft
6"	14 ga.	.083	9-5147	4.8/ft	7.00/ft
6"	12 ga.	.105	4-0512	6.8/ft	8.60/ft
6"	10 ga.	.135	9-5138	8.6/ft	11.00/ft
6"	10 ga. SS #304	.135	9-5162	8.6/ft	63.00/ft
6"	7 ga. (3/16")	.188	9-5151	11.6/ft	15.00/ft
6-5/8"	12 ga.	.105	4-0513	7.9/ft	10.50/ft
6-5/8"	10 ga.	.135	9-5139	9.6/ft	13.00/ft
6-5/8"	7 ga. (3/16")	.188	9-5152	12.9/ft	9.00/ft
8"	14 ga.	.083	9-5148	6.5/ft	9.00/ft
8"	12 ga.	.105	4-0514	9.0/ft	11.50/ft
8"	11 ga.	.125	9-5144	10.3/ft	9.00/ft
8"	10 ga.	.135	9-5140	11.6/ft	15.00/ft
8"	10 ga. SS #304	.135	9-5163	11.6/ft	81.00/ft
8"	7 ga. (3/16")	.188	9-5153	15.6/ft	20.00/ft
8-5/8"	12 ga.	.105	4-0515	9.8/ft	15.00/ft
10"	12 ga.	.105	4-0516	12.2/ft	14.50/ft
10"	10 ga.	.135	9-5136	14.5/ft	19.00/ft
10"	7 ga. (3/16")	.188	9-5150	19.7/ft	28.00/ft
10-3/4"	10 ga.	.135	9-5287	15.6/ft	15.00/ft
12"	12 ga.	.105	4-0517	13.6/ft	21.00/ft
12"	10 ga.	.135	9-5307	17.5/ft	23.00/ft
12-3/4"	10 ga.	.135	9-5288	18.6/ft	37.00/ft

Pipe

ALUMINUM TUBING



Diameter	Wall			
2"	.050	4-0540	.36/ft	Call
3"	.050	4-0541	.54/ft	Call
4"	.050	4-0520	.73/ft	Call
4"	.072	4-0542	1.05/ft	Call
5"	.052	4-0543	.94/ft	Call
5"	.078	4-0544	1.42/ft	Call
6"	.051	4-0521	1.10/ft	Call
6"	.058	4-0522	1.26/ft	Call
6"	.083	4-0545	1.81/ft	Call
7"	.064	4-0546	1.64/ft	Call
8"	.051	4-0523	1.50/ft	Call
8"	.064	4-0524	1.88/ft	Call
8"	.072	4-0547	2.11/ft	Call
8"	.090	4-0548	2.78/ft	Call
9"	.051	4-0621	1.75/ft	Call
9"	.064	4-0529	2.24/ft	Call
10"	.051	4-0525	1.90/ft	Call
10"	.064	4-0526	2.38/ft	Call
10"	.094	4-0549	3.44/ft	Call
12"	.064	4-0550	2.86/ft	Call
12"	.094	4-0551	4.19/ft	Call

Product	Description	Part Number	Weight	List Price
---------	-------------	-------------	--------	------------

ALUMINUM GATED PIPE - .051*

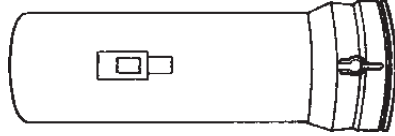

*Gates included, but not installed.

	<u>Gates/Pipe</u>			
6" x 20' - 20"	12	4-0310	1.18	Call
6" x 20' - 30"	8	4-0320	1.18	Call
6" x 20' - 40"	6	4-0330	1.18	Call
6" x 30' - 20"	18	4-0311	1.15	Call
6" x 30' - 30"	12	4-0321	1.15	Call
6" x 30' - 36"	10	4-0323	1.15	Call
6" x 30' - 40"	40	4-0331	1.15	Call
6" x 40' - 20"	24	4-0312	1.14	Call
6" x 40' - 30"	16	4-0322	1.14	Call
6" x 40' - 40"	12	4-0332	1.14	Call
8" x 20' - 20"	12	4-0340	1.62	Call
8" x 20' - 30"	8	4-0350	1.62	Call
8" x 20' - 40"	6	4-0360	1.62	Call
8" x 30' - 20"	18	4-0341	1.58	Call
8" x 30' - 30"	12	4-0351	1.58	Call
8" x 30' - 36"	10	4-0353	1.58	Call
8" x 30' - 40"	9	4-0361	1.58	Call
8" x 40' - 20"	24	4-0342	1.56	Call
8" x 40' - 30"	16	4-0352	1.56	Call
8" x 40' - 40"	12	4-0362	1.56	Call
10" x 20' - 20"	12	4-0370	2.13	Call
10" x 20' - 30"	8	4-0380	2.13	Call
10" x 20' - 40"	6	4-0390	2.13	Call
10" x 30' - 20"	18	4-0371	2.05	Call
10" x 30' - 30"	12	4-0381	2.05	Call
10" x 30' - 36"	10	4-0383	2.05	Call
10" x 30' - 40"	9	4-0391	2.05	Call
10" x 40' - 20"	24	4-0372	2.01	Call
10" x 40' - 30"	16	4-0382	2.01	Call
10" x 40' - 40"	12	4-0392	2.01	Call

CORRUGATED PLASTIC DRAINAGE PIPE

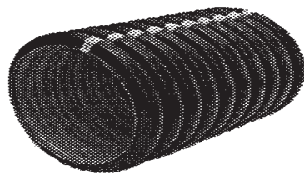

Available perforated or non-perforated. Please call for fittings.

3"	4-0700	Call
4"	4-0701	Call
5"	4-0702	Call
6"	4-0703	Call
8"	4-0704	Call
10"	4-0705	Call
12"	4-0706	Call
15"	4-0707	Call
18"	4-0708	Call
24"	4-0709	Call
Smooth Interior: 12"	4-0710	Call
15"	4-0711	Call
18"	4-0712	Call
24"	4-0713	Call

* Quantity and Truckload Discounts available. Please Call.

**PVC SURFACE GATED /
STANDARD WALL**



Standard wall

	Wall			
6" x 30' - plain	.12	4-3305	1.5/ft	Call
6" x 30' - 20"	.12	4-3311	1.5/ft	Call
6" x 30' - 30"	.12	4-3321	1.5/ft	Call
6" x 30' - 36"	.12	4-3300	1.5/ft	Call
6" x 30' - 40"	.12	4-3331	1.5/ft	Call
8" x 30' - plain	.12	4-3306	2.0/ft	Call
8" x 30' - 20"	.12	4-3341	2.0/ft	Call
8" x 30' - 30"	.12	4-3351	2.0/ft	Call
8" x 30' - 36"	.12	4-3301	2.0/ft	Call
8" x 30' - 40"	.12	4-3361	2.0/ft	Call
10" x 30' - plain	.12	4-3307	2.5/ft	Call
10" x 30' - 20"	.12	4-3371	2.5/ft	Call
10" x 30' - 30"	.12	4-3381	2.5/ft	Call
10" x 30' - 36"	.12	4-3302	2.5/ft	Call
10" x 30' - 40"	.12	4-3391	2.5/ft	Call
12" x 30' - plain	.12	4-3308	3.0/ft	Call
12" x 30' - 20"	.12	4-3320	3.0/ft	Call
12" x 30' - 30"	.12	4-3324	3.0/ft	Call
12" x 30' - 36"	.12	4-3322	3.0/ft	Call
12" x 30' - 40"	.12	4-3323	3.0/ft	Call

*Above w/b&h will take 20-25 psi
- Compatible w/Aluminum pipe and fittings
- Adjustable Telescopic Coupler

Pipe

**PVC SURFACE GATED /
LIGHT WALL**

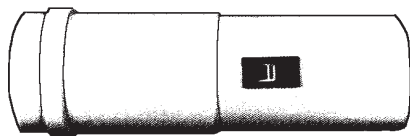

Light wall

6" x 30' - plain	.10	4-3600	1.25/ft	Call
6" x 30' - 20"	.10	4-3601	1.25/ft	Call
6" x 30' - 30"	.10	4-3602	1.25/ft	Call
6" x 30' - 36"	.10	4-3603	1.25/ft	Call
6" x 30' - 40"	.10	4-3604	1.25/ft	Call
8" x 30' - plain	.09	4-3309	1.6/ft	Call
8" x 30' - 20"	.09	4-3330	1.6/ft	Call
8" x 30' - 30"	.09	4-3334	1.6/ft	Call
8" x 30' - 36"	.09	4-3402	1.6/ft	Call
8" x 30' - 40"	.09	4-3403	1.6/ft	Call
10" x 30' - plain	.10	4-3310	2.1/ft	Call
10" x 30' - 20"	.10	4-3404	2.1/ft	Call
10" x 30' - 30"	.10	4-3405	2.1/ft	Call
10" x 30' - 36"	.10	4-3406	2.1/ft	Call
10" x 30' - 40"	.10	4-3407	2.1/ft	Call

*Above w/b&h will take 20-25 psi.

Product	Description	Part Number	Weight	List Price		
RINGLOCK HEAVY WALL ALUMINUM W/BIG GUN COUPLER				<u>Wall Max PSI</u>		
		6" x 20' .058	150#	4-0220	1.53	Call
		6" x 30' .058	150#	4-0221	1.44	Call
		6" x 40' .058	150#	4-0222	1.39	Call
		8" x 20' .064	150#	4-0260	2.23	Call
		8" x 30' .064	150#	4-0261	2.11	Call
		8" x 40' .064	150#	4-0262	2.06	Call
		10" x 20' .064	125#	4-0290	2.79	Call
		10" x 30' .064	125#	4-0291	2.65	Call
		10" x 40' .064	125#	4-0292	2.58	Call

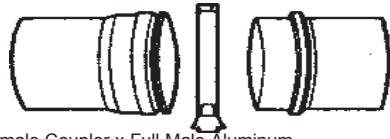

Big Gun Female Coupler x Full Male Aluminum Ring. Ringlock Clamp included.

Product	Description	Part Number	Weight	List Price	
TWIST LOCK PIPE				<u>Wall Max PSI</u>	
		4" x 20' .050	150#	4-0715	Call
		4" x 30' .050	150#	4-0716	Call
		4" x 40' .050	150#	4-0717	Call
		5" x 20' .051	150#	4-0718	Call
		5" x 30' .051	150#	4-0719	Call
		5" x 40' .051	150#	4-0720	Call
		6" x 20' .058	150#	4-0721	Call
		6" x 30' .058	150#	4-0722	Call
		6" x 40' .058	150#	4-0723	Call
		8" x 20' .064	125#	4-0724	Call
		8" x 30' .064	125#	4-0725	Call
		8" x 40' .064	125#	4-0726	Call

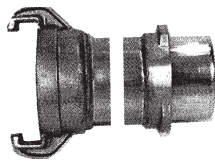

Product	Description	Part Number	Weight	List Price	
REPLACEMENT COUPLER, PVC SURFACE		6"	4-3392	1.5	27.50
		8"	4-3393	3.0	31.50
		10"	4-3394	3.5	40.00
		12"	4-4400	4.0	50.00



Product	Description	Part Number	Weight	List Price	
REPAIR SPLICER, PVC SURFACE		6"	4-3395	0.5	9.00
		8"	4-3396	1.0	11.00
		10"	4-3397	1.0	15.00
		12"	4-4401	1.5	21.00



Product	Description	Part Number	Weight	List Price	
STEEL COLLAR FOR PVC SURFACE		6"	4-3398	1.3	7.00
		8"	4-3399	1.6	8.00
		10"	4-3400	2.0	9.00
		12"	4-3401	2.5	10.00



Product	Description	Part Number	Weight	List Price
CAPLOCK		6"	4-4402	27.00
		8"	4-4403	30.00
		10"	4-4404	35.00
		12"	4-4405	37.00

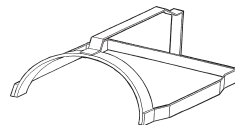

Features:

1. Easy to use
2. Saves time and money
3. Insert the plug and snap on the caplock

ALUMINUM VACUUM PIPE

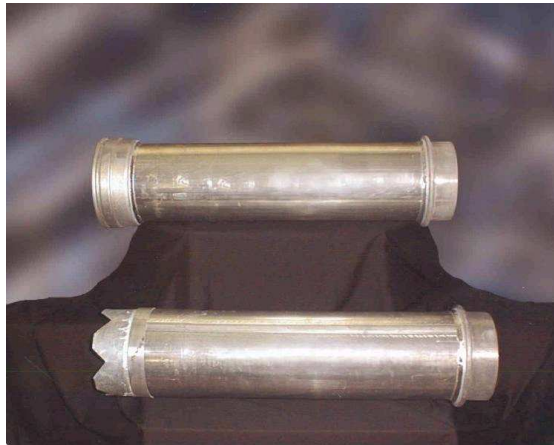

-Tough, durable aluminum vacuum pipe is available in a number of types of connections.
-We also manufacture vacuum fittings such as elbow, tees, end plugs, etc.

Size	Length	Wall	Type	Part #	List Price
4"	5'	0.072	Cast Alum Ball/Socket w/lever	9-5062	111.00
4"	10'	0.072	Cast Alum Ball/Socket w/lever	9-5063	132.00
4"	15'	0.072	Cast Alum Ball/Socket w/lever	9-5064	154.00
4"	20'	0.072	Cast Alum Ball/Socket w/lever	9-5065	175.00
4"	25'	0.072	Cast Alum Ball/Socket w/lever	9-5066	197.00
4"	30'	0.072	Cast Alum Ball/Socket w/lever	9-5067	222.00
6"	5'	0.083	Cast Alum Ball/Socket w/lever	9-5068	185.00
6"	10'	0.083	Cast Alum Ball/Socket w/lever	9-5069	222.00
6"	15'	0.083	Cast Alum Ball/Socket w/lever	9-5070	260.00
6"	20'	0.083	Cast Alum Ball/Socket w/lever	9-5071	300.00
6"	25'	0.083	Cast Alum Ball/Socket w/lever	9-5072	343.00
6"	30'	0.083	Cast Alum Ball/Socket w/lever	9-5073	388.00
8"	5'	0.094	Cast Alum Ball/Socket w/lever	9-5074	298.00
8"	10'	0.094	Cast Alum Ball/Socket w/lever	9-5075	356.00
8"	15'	0.094	Cast Alum Ball/Socket w/lever	9-5076	415.00
8"	20'	0.094	Cast Alum Ball/Socket w/lever	9-5077	475.00
8"	25'	0.094	Cast Alum Ball/Socket w/lever	9-5078	545.00
8"	30'	0.094	Cast Alum Ball/Socket w/lever	9-5079	713.00
4"	5'	0.072	Gal. Steel Ball/Socket 100/200	9-5080	103.00
4"	10'	0.072	Gal. Steel Ball/Socket 100/200	9-5081	129.00
4"	15'	0.072	Gal. Steel Ball/Socket 100/200	9-5082	153.00
4"	20'	0.072	Gal. Steel Ball/Socket 100/200	9-5083	189.00
4"	25'	0.072	Gal. Steel Ball/Socket 100/200	9-5084	202.00
4"	30'	0.072	Gal. Steel Ball/Socket 100/200	9-5085	227.00
6"	5'	0.083	Gal. Steel Ball/Socket 100/200	9-5086	150.00
6"	10'	0.083	Gal. Steel Ball/Socket 100/200	9-5087	195.00
6"	15'	0.083	Gal. Steel Ball/Socket 100/200	9-5088	240.00
6"	20'	0.083	Gal. Steel Ball/Socket 100/200	9-5089	298.00
6"	25'	0.083	Gal. Steel Ball/Socket 100/200	9-5090	332.00
6"	30'	0.083	Gal. Steel Ball/Socket 100/200	9-5091	389.00
8"	5'	0.094	Gal. Steel Ball/Socket 100/200	9-5092	229.00
8"	10'	0.094	Gal. Steel Ball/Socket 100/200	9-5093	295.00
8"	15'	0.094	Gal. Steel Ball/Socket 100/200	9-5094	369.00
8"	20'	0.094	Gal. Steel Ball/Socket 100/200	9-5095	439.00
8"	25'	0.094	Gal. Steel Ball/Socket 100/200	9-5096	510.00
8"	30'	0.094	Gal. Steel Ball/Socket 100/200	9-5097	579.00
4"	5'	0.072	Cast Alum Ring Lock w/rc	9-5098	85.00
4"	10'	0.072	Cast Alum Ring Lock w/rc	9-5099	110.00
4"	15'	0.072	Cast Alum Ring Lock w/rc	9-5100	135.00
4"	20'	0.072	Cast Alum Ring Lock w/rc	9-5101	159.00
4"	25'	0.072	Cast Alum Ring Lock w/rc	9-5102	185.00
4"	30'	0.072	Cast Alum Ring Lock w/rc	9-5103	209.00
6"	5'	0.083	Cast Alum Ring Lock w/rc	9-5104	128.00
6"	10'	0.083	Cast Alum Ring Lock w/rc	9-5105	173.00
6"	15'	0.083	Cast Alum Ring Lock w/rc	9-5106	219.00
6"	20'	0.083	Cast Alum Ring Lock w/rc	9-5107	265.00
6"	25'	0.083	Cast Alum Ring Lock w/rc	9-5108	310.00
6"	30'	0.083	Cast Alum Ring Lock w/rc	9-5109	355.00
8"	5'	0.094	Cast Alum Ring Lock w/rc	9-5110	168.00
8"	10'	0.094	Cast Alum Ring Lock w/rc	9-5111	238.00
8"	15'	0.094	Cast Alum Ring Lock w/rc	9-5112	308.00
8"	20'	0.094	Cast Alum Ring Lock w/rc	9-5113	378.00
8"	25'	0.094	Cast Alum Ring Lock w/rc	9-5114	449.00
8"	30'	0.094	Cast Alum Ring Lock w/rc	9-5115	519.00
4"	5'	0.072	Gal. Steel Ball/Socket 100/200	9-5116	78.00
4"	10'	0.072	Gal. Steel Ball/Socket 100/200	9-5117	102.00
4"	15'	0.072	Gal. Steel Ball/Socket 100/200	9-5118	129.00
4"	20'	0.072	Gal. Steel Ball/Socket 100/200	9-5119	152.00
4"	25'	0.072	Gal. Steel Ball/Socket 100/200	9-5120	189.00
4"	30'	0.072	Gal. Steel Ball/Socket 100/200	9-5121	202.00
6"	5'	0.083	Gal. Steel Ball/Socket 100/200	9-5122	113.00
6"	10'	0.083	Gal. Steel Ball/Socket 100/200	9-5123	159.00
6"	15'	0.083	Gal. Steel Ball/Socket 100/200	9-5124	203.00
6"	20'	0.083	Gal. Steel Ball/Socket 100/200	9-5125	250.00
6"	25'	0.083	Gal. Steel Ball/Socket 100/200	9-5126	205.00
6"	30'	0.083	Gal. Steel Ball/Socket 100/200	9-5127	341.00
8"	5'	0.094	Gal. Steel Ball/Socket 100/200	9-5128	154.00
8"	10'	0.094	Gal. Steel Ball/Socket 100/200	9-5129	225.00
8"	15'	0.094	Gal. Steel Ball/Socket 100/200	9-5130	295.00
8"	20'	0.094	Gal. Steel Ball/Socket 100/200	9-5131	364.00
8"	25'	0.094	Gal. Steel Ball/Socket 100/200	9-5132	435.00
8"	30'	0.094	Gal. Steel Ball/Socket 100/200	9-5133	503.00

Pipe

PVC UNDERGROUND PIPE

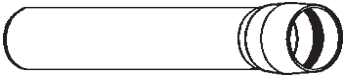
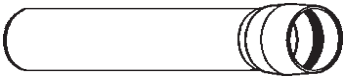
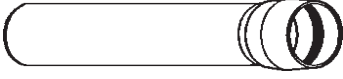
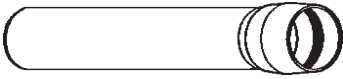

Product	Description		Part Number	Weight	List Price			
	Diameter	O D	I D	Thickness	SDR			
50# PVC GASKETED PIPE  *Solvent	*6" PIP	6.14	5.989	.760	81	4-0610	1.1/ft	Call
	8" PIP	8.16	7.958	.101	81	4-0650	1.7/ft	Call
	10" PIP	10.20	9.948	.126	81	4-0681	2.6/ft	Call
	12" PIP	12.24	11.938	.151	81	4-0691	3.8/ft	Call
	15" PIP	15.30	14.922	.189	81	4-0695	5.8/ft	Call
	*16" PIP	16.000	15.608	.196	81	4-0696	6.5/ft	Call
80# PVC GASKETED PIPE 	6" PIP	6.14	5.90	.12	51	4-0620	1.5/ft	Call
	8" PIP	8.16	7.84	.16	51	4-0660	2.6/ft	Call
	10" PIP	10.20	9.80	.20	51	4-0682	4.1/ft	Call
	12" PIP	12.24	11.76	.24	51	4-0692	6.1/ft	Call
	15" PIP	15.30	14.70	.30	51	4-0697	9.4/ft	Call
	18" PIP	18.70	17.96	.37	51	4-0800	14.3/ft	Call
	21" PIP	22.05	21.19	.43	51	4-0802	19.8/ft	Call
	24" PIP	24.80	23.83	.49	51	4-0804	26.1/ft	Call
27" PIP	27.95	26.86	.55	51	4-0806	33.6/ft	Call	
100# PVC GASKETED PIPE 	4" IPS	4.50	---	---	41	4-0644	1.0/ft	Call
	6" IPS	6.63	6.30	.162	41	4-0850	2.2/ft	Call
	8" IPS	8.63	8.21	.210	41	4-0851	3.6/ft	Call
	10" IPS	10.75	10.23	.262	41	4-0852	5.7/ft	Call
	12" IPS	12.75	12.13	.311	41	4-0853	8.0/ft	Call
	6" PIP	6.14	5.84	.150	41	4-0630	1.9/ft	Call
	8" PIP	8.16	7.76	.199	41	4-0670	3.3/ft	Call
	10" PIP	10.20	9.70	.249	41	4-0683	5.1/ft	Call
	12" PIP	12.24	11.64	.299	41	4-0693	7.5/ft	Call
	15" PIP	15.30	14.46	.373	41	4-0698	11.7/ft	Call
	18" PIP	18.7	17.78	.456	41	4-0801	17.6/ft	Call
	21" PIP	22.05	20.97	.538	41	4-0803	24.6/ft	Call
	24" PIP	24.8	23.59	.605	41	4-0805	32.4/ft	Call
	27" PIP	27.95	26.59	.683	41	4-0807	41.8/ft	Call
125# PVC GASKETED PIPE  *Solvent	1-1/4" IPS*	1.77	1.380	.197	32.5	4-3501	0.4/ft	Call
	2" IPS	2.38	2.229	.073	32.5	4-3504	0.3/ft	Call
	2-1/2" IPS	2.88	2.195	.088	32.5	4-0814	0.5/ft	Call
	3" IPS	3.50	2.830	.108	32.5	4-0815	0.7/ft	Call
	4" IPS	4.50	4.224	.138	32.5	4-0639	1.3/ft	Call
	6" IPS	6.63	6.217	.204	32.5	4-0855	2.7/ft	Call
	8" IPS	8.63	8.095	.265	32.5	4-0856	4.6/ft	Call
	10" IPS	10.75	10.088	.331	32.5	4-0857	7.1/ft	Call
	12" IPS	12.75	11.966	.392	32.5	4-0858	9.9/ft	Call
	6" PIP	6.14	5.762	.189	32.5	4-0640	2.3/ft	Call
	8" PIP	8.16	7.658	.251	32.5	4-0680	4.2/ft	Call
	10" PIP	10.20	9.572	.314	32.5	4-0684	6.4/ft	Call
12" PIP	12.24	11.49	.377	32.5	4-0694	9.4/ft	Call	
15" PIP	15.30	14.36	.471	32.5	4-0699	14.8/ft	Call	

All PVC is in 20' or 40' lengths. Gaskets are included. Call for installed prices.

Pieces/Truckload:	6"	8"	10"	12"
50# PIP	285	158	103	70
80/100/125# PIP	261	143	90	63
125/160# IPS	210	110	72	--

160# PVC GASKETED PIPE

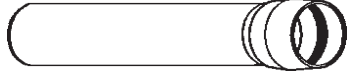

Diameter	OD	ID	Thickness	SDR			
1" IPS*	--	--	--	26	4-0816	--	Call
1-1/4" IPS*	1.66	1.532	0.064	26	4-3502	0.2/ft	Call
1-1/2" IPS	1.90	1.754	0.073	26	4-3503	0.3/ft	Call
2" IPS	2.38	2.193	0.091	26	4-3505	0.4/ft	Call
2-1/2" IPS	2.88	2.655	0.110	26	4-3506	0.6/ft	Call
3" IPS	3.50	3.230	0.135	26	4-3508	0.9/ft	Call
4" IPS	4.50	4.154	0.173	26	4-0671	1.6/ft	Call
6" IPS	6.63	6.115	0.255	26	4-0672	3.4/ft	Call
8" IPS	8.63	7.961	0.332	26	4-0673	5.7/ft	Call
10" IPS	10.75	9.924	0.413	26	4-0674	8.9/ft	Call
12" IPS	12.75	11.77	0.490	26	4-0808	12.67/ft	Call

*Solvent

200# PVC GASKETED PIPE



1/2" IPS*	.84	.716	0.022	13.5	4-0817	0.098/ft	Call
3/4" IPS*	1.05	.930	0.060	21	4-0818	0.122/ft	Call
1" IPS*	1.315	1.189	0.063	21	4-3500	0.164/ft	Call
1-1/4" IPS*	1.660	1.502	0.079	21	4-0819	0.259/ft	Call
1-1/2" IPS	1.900	1.720	0.090	21	4-0820	0.338/ft	Call
2" IPS	2.375	2.149	0.113	21	4-3507	0.530/ft	Call
2-1/2" IPS	2.875	2.601	0.137	21	4-0821	0.776/ft	Call
3" IPS	3.500	3.166	0.167	21	4-0822	1.154/ft	Call
4" IPS	4.500	4.072	0.214	21	4-0809	1.900/ft	Call
6" IPS	6.625	5.993	0.316	21	4-0810	4.150/ft	Call
8" IPS	8.625	7.805	0.410	21	4-0811	7.055/ft	Call
10" IPS	10.75	9.728	0.500	21	4-0812	10.99/ft	Call
12" IPS	12.75	11.54	0.606	21	4-0813	15.53/ft	Call

*Solvent

SCHEDULE 40 PVC PIPE, SOLVENT

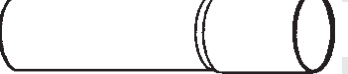

1/2"	0.840	0.612	0.109	--	4-0823	0.164/ft	Call
3/4"	1.050	0.824	0.113	--	4-0824	0.219/ft	Call
1"	1.315	1.049	0.133	--	4-0825	0.325/ft	Call
1-1/4"	1.660	1.380	0.140	--	4-0826	0.440/ft	Call
1-1/2"	1.900	1.610	0.145	--	4-0827	0.526/ft	Call
2"	2.375	2.067	0.154	--	4-0828	0.708/ft	Call
2-1/2"	2.875	2.469	0.203	--	4-0829	1.123/ft	Call
3"	3.500	3.068	0.216	--	4-0830	1.469/ft	Call
4"	4.500	4.026	0.237	--	4-0831	2.090/ft	Call
6"	6.625	6.065	0.280	--	4-0832	3.680/ft	Call
8"	8.625	7.962	0.332	--	4-0833	5.590/ft	Call

SCHEDULE 80 PVC PIPE, SOLVENT



1/2"	0.840	0.546	0.147	--	4-0834	0.205/ft	Call
3/4"	1.050	0.742	0.154	--	4-0835	0.278/ft	Call
1"	1.315	0.957	0.179	--	4-0836	0.409/ft	Call
1-1/4"	1.660	1.278	0.191	--	4-0837	0.567/ft	Call
1-1/2"	1.900	1.500	0.200	--	4-0838	0.686/ft	Call
2"	2.375	1.939	0.218	--	4-0839	0.949/ft	Call
2-1/2"	2.875	2.323	0.276	--	4-0840	1.449/ft	Call
3"	3.500	2.900	0.300	--	4-0841	1.938/ft	Call
4"	4.500	3.826	0.337	--	4-0842	2.833/ft	Call
6"	6.625	5.761	0.432	--	4-0843	5.446/ft	Call
8"	8.625	7.625	0.500	--	4-0844	8.270/ft	Call

All PVC is in 20' or 40' lengths. Gaskets are included. Call for installed prices.

Pieces/Truckload:	6"	8"	10"	12"
50# PIP	285	158	103	70
80/100/125# PIP	261	143	90	63
125/160# IPS	210	110	72	--

Product	Description	Part Number	Weight	List Price
DAM GATE	6"	4-0460	.1	1.00
	8"-10"-12"	4-0461	.1	1.00

Fits standard 1-1/4" x 2-5/8" Rectangle Hole

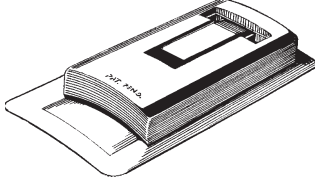

- Features:
1. Quick easy installation
 2. Designed for use in either PVC or aluminum pipe
 3. Fits standard 1 1/4" x 2 5/8" rectangular openings
 4. Fits Tex-Flo openings
 5. New design allows easier slide adjustments
 6. Spring tension is at the center for equal sealing at front and rear of the gate
 7. Manufactured from special materials to minimize environmental effects
 8. UV inhibitor is added to help protect against the sun's ultra violet radiation
 9. Water flow 90 GPM at 6 feet of head

ROUGHNECK GATE	Rectangle, 6"	4-0219	.1	1.00
	Rectangle, 8" - 10"	4-0200	.1	0.90
	Keyhole, 8" - 10"	4-0201	.1	0.90
	Keyhole, 6"	6-9789	.1	0.90

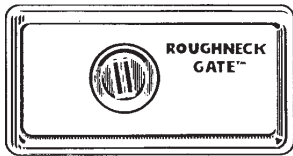

Keyhole

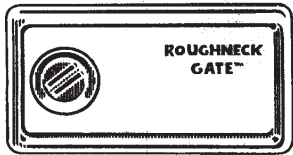

Rectangle

Fits standard 1-1/4" x 2-5/8" Rectangle Hole
Roughneck gates preform better in sunlight and will not stick to Alum or PVC pipe.

- Features:
1. Can be adjusted again and again to maintain leak-proof seats
 2. Screw interlock holds tension until you change it. Adjustable gates substantially reduce water leakage.
 3. Interlocking feature of top and screw-head reduces the possibility of the screw loosening
 4. No tools are necessary to install or remove gate
 5. Built with the most durable material available for irrigation gates and have no metal parts to corrode.

RECTANGLE GATE FOR ALUMINUM/PVC PIPE	8"-10"	4-0432	.1	1.30
---	--------	--------	----	-------------

Fits standard 1-1/4" x 2-5/8" Rectangle Hole



KEYHOLE GATE	6"	4-0436	.1	1.20
	8"-10"	4-0441	.1	1.20

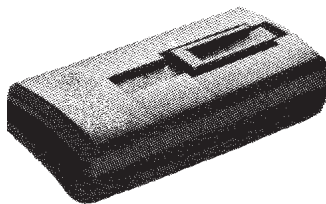

1. The triad keyhole gate is a fresh approach to irrigation gate problems. The spring mechanism is so unique a patent has been applied for.
2. Easiest keyhole gate on the market to install.
3. Manufactured from specially selected materials to minimize environmental effects
4. Fits standard keyhole openings
5. Excellent water flow, 60 GPM at 6 feet of head

HASTINGS GATE

*Universal, 8"-9"-10"	4-0462	.1	1.05
Round Front, 6"	4-0463	.1	1.35
Round Front, 8"-9"-10"	4-0464	.1	1.35
Conversion, 1-5/8"x4-1/4" Hole	4-0465	.2	2.60

Features:

- Up to 85 GPM with a 42" head
- Open, adjust and closes easily from a standing position with just the tap of a stick
- Yellow Top: made of high strength, long-lasting natural polypropylene
- Bottom: spring tension holds the gate firmly in any position in which the gate is set. Gasket is firmly molded to the bottom, holding it tightly against the pipe.
- Gasket: new, improved design of molded sythetic rubber. This new material is more flexible, conforms more readily to the contour of the pipe

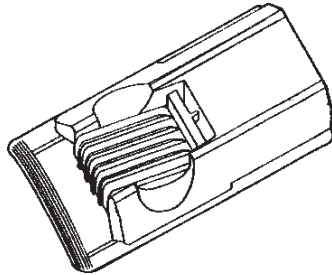

Universal (will fit round front gate hole)

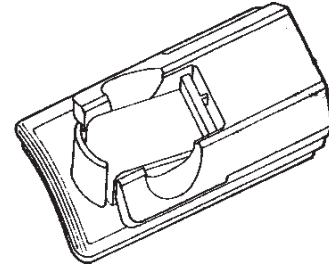

Round Front

RITE-FLO SCREW GATE GASKETS (ONLY)



Midget:

Washer Gasket (outside)	4-0451	--	0.40
Core Gasket (inner)	4-0452	--	0.40

Giant (2-1/2"):

Washer Gasket, Giant (outside)	4-0487	--	0.55
Core Gasket, Giant (inner)	4-0486	--	0.45



Pipe

NU-SLIDE GATE

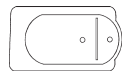

Rubber Bottom only	4-0495	--	3.30
Screw (need 2/gate)	4-0496	--	0.35

OVAL GATE

one size	4-0470	.3	1.80
----------	--------	----	------





Features:

- Easily installed in a standard recessed oval hole (ames type)
- Improved frame design
- Flow rate 60 gallons per minute at 1 foot of head, full open
- Easily adjustable slide regulates water flow
- Manufactured from specially selected materials to improve weatherability

GATES & GATE SOCKS



Product	Description	Part Number	Weight	List Price
 Round	Round 6"	4-0480	0.15	2.10
	Round 8"	4-0481	0.17	2.40
	Round 10"	4-0482	0.19	2.80
	Round 12"	4-0483	0.21	3.00

 *36" long with closed end	Neoprene	4-0490	.12	3.40
--	----------	--------	-----	------

	6"	4-0475	10.25	160.00
	8"	4-0476	11.25	160.00
	9"	4-0477	12.25	160.00
	10"	4-0478	12.25	160.00
	12"	4-0479	12.75	145.00

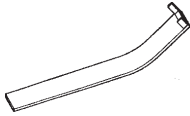
	--	6-1814		4.00
---	----	--------	--	------

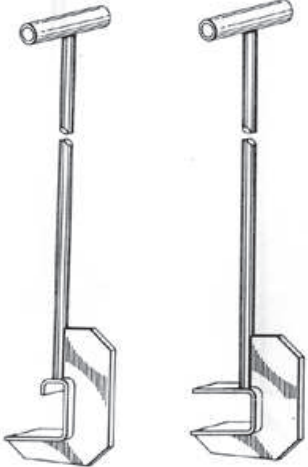
 w/groove wo/groove	With Groove	8-1429	53.00
	Without Groove	8-1430	53.00
	For PVC Pipe	9-5286	105.00