

Section Five

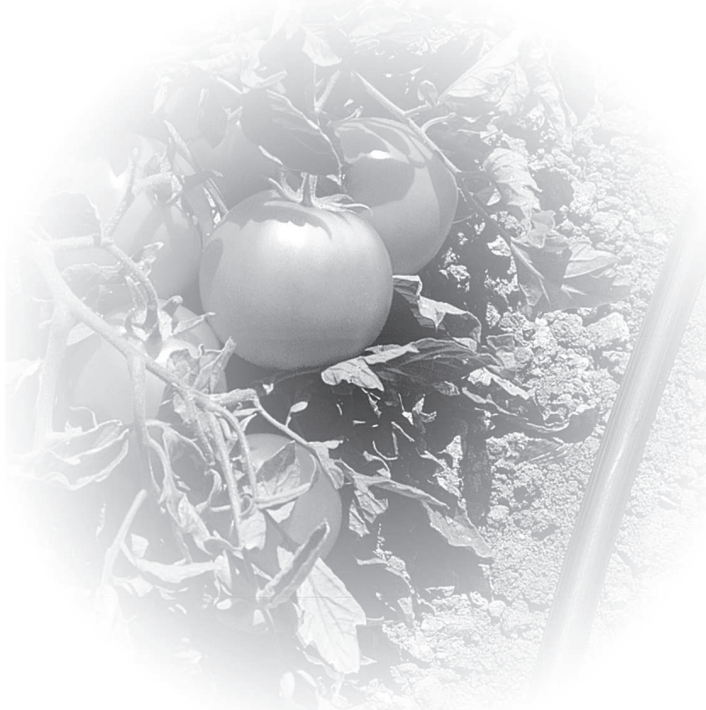

Couplers & Accessories
Ball & Socket Fittings
Cam-Loc Fittings
Elbows
End Tees
Line Tees & Y Tees
Reducers & Increases
End Plugs & End Caps
Hooks & Bands
Latch Accessories
Rings & Accessories

Flanges & Disks
Cones
Telescopes & Drop Pipe
Valves & Valve Parts
Meters
Pivot Parts
Nipples, Couplings & Tees
Drip Products
Filters
Gaskets



**CAST ALUMINUM,
WELD-ON**



6" & 8" Lindsay require oversize RLC
*6"&10" take standard RLC, 8" requires oversized RLC

3"	6-0114	1.0	17.00
4"	6-0110	1.1	20.00
5"	6-0115	1.3	25.00
6"	6-0111	1.5	27.00
7"	6-0109	2.5	31.00
8"	6-0112	2.3	34.00
10"	6-0113	4.5	42.00

**STEEL,
BLACK WELD-ON**



2"	6-0120	0.5	10.00
3"	6-0121	1.3	8.00
4"	2-3/4" Depth 6-0122	2.0	10.00
5"	6-0123	2.0	12.00
6"	3-1/2" Depth 6-0124	2.8	14.00
6-5/8"	6-0128	3.8	19.00
7"	6-0118	3.5	17.00
8"	3-1/2" Depth 6-0125	5.0	18.00
8-5/8"	6-0129	6.0	39.00
10"	3" Depth 6-0126	6.0	25.00
12"	6-0127	9.0	38.00
12 Gauge	4" 6-8030	3.0	16.00
Stainless Steel (#304)	4" 6-9936	2.0	56.00
Stainless Steel (#304)	6" 6-9937	2.8	72.00
Stainless Steel (#304)	8" 6-9938	5.0	128.00
Deep Punch (3" depth)	3" 9-5198		7.00
Deep Punch (4" depth)	4" 9-5199		15.00
Deep Punch (4" depth)	5" 9-5201		16.00
Deep Punch (5-7/8" depth)	6" 9-5010		18.20
Deep Punch (5-1/2" depth)	8" 9-5011		34.00
Deep Punch (6" depth)	10" 9-5012		26.00
Deep Punch (6" depth)	12" 9-5013		43.00
Extra Deep Punch (4" depth)	3" 9-5007		9.00
Extra Deep Punch (4.5" depth)	4" 9-5008		12.50
Extra Deep Punch (5" depth)	5" 9-5009		15.00
Extra Deep Punch (8.5" depth)	6" 9-5202		35.00
Extra Deep Punch (11" depth)	8" 9-5203		46.00
Extra-Extra Deep Punch (7" depth)	4" 9-5200		25.00

**STEEL,
10 GA. WELD ON**



10 Gauge

6" Black 10 ga.	6-9662	--	25.00
8" Black 10 ga.	6-9663	--	31.00
10" Black 10 ga.	9-5305		38.00
6" Gal w / welding strip 10 ga.	6-9664	3.0	30.00
8" Gal w / welding strip 10 ga.	6-9665	6.0	38.00

**MALE RINGLOCK,
BLACK WELD-ON**



12 Gauge with wider ring
Stainless Steel
Stainless Steel
Stainless Steel

3"	6-0169	1.0	8.50
4"	6-0170	2.0	10.00
5"	6-0171	2.5	11.00
6"	6-0172	3.0	13.00
7"	6-0176	4.5	17.00
8"	6-0173	5.0	17.00
10"	6-0174	7.0	25.00
12"	6-0175	10.0	36.00
12 Gauge with wider ring	4" 6-8112	3.0	16.00
Stainless Steel	4" 6-9933	2.0	57.00
Stainless Steel	6" 6-9934	3.0	99.00
Stainless Steel	8" 6-9935	5.0	90.00

**MALE RINGLOCK,
10 GA. WELD-ON**



10 Gauge

6" Black 10 ga.	6-9764		19.00
8" Black 10 ga.	6-9765		26.00
10" Black 10 ga.	9-5306		37.00
6" Gal w / welding strip 10 ga.	6-9766		24.00
8" Gal w / welding strip 10 ga.	6-9767		30.00

Fittings

COUPLERS



Product	Description	Part Number	Weight	List Price
CAST SCHUMACHER HEAT TREATED, RL WELD-ON	Set 4"	6-0145		44.00
	Set 5"	6-0146		58.00
	Set 6"	6-0130	5.3	61.00
	Set 7"	6-0134	6.3	76.00
	Set 8"	6-0131	7.0	78.00
	Set 10"	6-0132	8.1	96.00
	Set 12"	6-0133	10.0	132.00
	Female HT, 4"	6-0147		20.00
	Female HT, 5"	6-0148		26.00
	Female HT, 6"	6-0150	2.4	28.00
	Female HT, 7"	6-0153	2.5	34.00
	Female HT, 8"	6-0151	2.8	36.00
Female HT, 10"	6-0152	3.5	45.00	
Female HT, 12"	4-0015	5.5	69.00	
Set Includes Standard Ringlock Clamp	Male HT, 4"	6-0149	1.8	14.00
	Male HT, 5"	6-0154	1.9	18.00
	Male HT, 6"	6-0160	2.0	20.00
	Male HT, 7"	6-0163	2.3	24.00
	Male HT, 8"	6-0161	3.5	26.00
	Male HT, 10"	6-0162		31.00
	Male HT, 12"	4-0016		40.00



CAST A&M COUPLER, RL WELD-ON



Set Includes A&M Ringlock Clamp

Male RL, 6"	6-0086	--	17.00
Male RL, 8"	6-0087	--	22.00
Male RL, 10"	6-0088	--	28.00
Female RL, 6"	6-0089	--	26.00
Female RL, 8"	6-0090	--	33.00
Female RL, 10"	6-0091	--	40.00
Set RL, 6"	6-0080	--	61.00
Set RL, 8"	6-0081	--	74.00
Set RL, 10"	6-0082	--	89.00

STEEL PRESS-ON COUPLER, GAL. STEEL



3" Male	6-0201	2.0	12.60
4" Male	6-0202	2.5	13.50
5" Male	6-0203	3.0	16.00
6" Male	6-0210	4.0	18.00
7" Male	6-0204	5.5	23.00
8" Male	6-0211	7.0	25.00
10" Male	6-0212	11.0	32.00
12" Male	6-0205	14.0	41.00
3" Female	6-0223	2.0	13.50
4" Female	6-0224	2.5	14.50
5" Female	6-0225	3.5	18.20
6" Female	6-0220	4.0	20.00
7" Female	6-0226	5.0	26.30
8" Female	6-0221	8.0	27.00
10" Female	6-0222	10.5	39.00
12" Female	6-0227	15.0	53.00

Screw, Self-tapping Set 6-4701 -- .90

STEEL HOLD BAND



3"	6-0235	.25	2.00
4"	6-0236	.30	2.50
5"	6-0237	.38	3.40
6"	6-0230	0.4	5.00
8"	6-0231	0.8	6.00
10"	6-0232	1.0	8.50

CAST LATERAL COUPLER

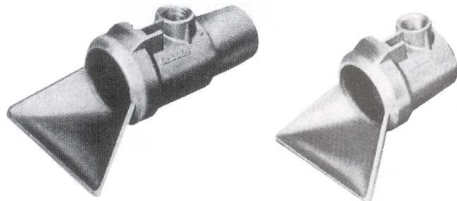

Press-on 2"	6-0241	1.3	24.00
Press-on 3"	6-0242	1.6	25.50
Press-on 4"	6-0240	2.0	33.00
Weld-on 2"	6-0260	1.2	17.00
Weld-on 3"	6-0261	1.5	25.00
Weld-on 4"	6-0262	2.0	33.00

All couplers have 1" outlet.

CAST KNOB PRESS-ON COUPLER

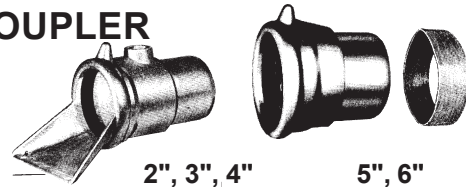

2" Lateral*	6-0263	1.0	25.00
3" Lateral*	6-0264	1.6	25.00
4" Lateral*	6-0265	2.3	32.00
5" Mainline	6-0266	2.7	35.00
6" Mainline	6-0267	3.4	45.00

*Lateral couplers have 1" outlet.

STEEL ABC COUPLER

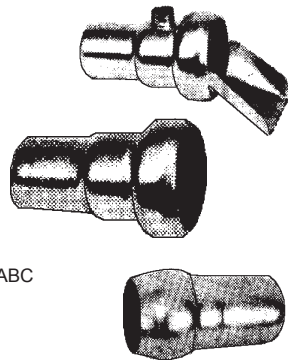

Call for prices on ABC Fittings.

Female w/1" outlet:	2"	6-0180	1.5	22.00
-Press-on	3"	6-0181	3.1	36.00
-Includes Spring & Gasket	4"	6-0182	5.5	51.00
Female Press-on:	2"	6-0183	1.0	14.00
	3"	6-0184	2.0	28.00
	4"	6-0185	3.9	42.00
	5"	6-0186	7.3	50.00
-Includes Spring & Gasket	6"	6-0187	9.4	70.00
	8"	6-0188	15.5	138.00
Male Press-on:	2"	6-0189	0.4	9.00
	3"	6-0190	1.2	14.00
	4"	6-0191	2.0	20.00
	5"	6-0192	4.8	40.00
	6"	6-0193	6.3	49.00
	8"	6-0194	13.0	112.00

Fittings

CAST LATERAL BOLT-ON COUPLER SET

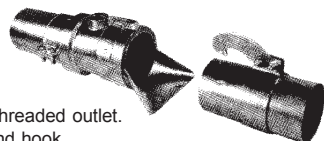

Has 1" Female threaded outlet.
Includes band and hook.

2"	6-0300	2.0	35.00
3"	6-0301	3.0	44.00
4"	6-0302	5.0	54.00
5"	6-0303	6.0	73.00
6"	6-0304	7.5	87.00

COUPLERS



Product	Description	Part Number	Weight	List Price	
CAST TWIST LOCK 	Female:	4"	6-0141	38.00	
		5"	6-0142	44.00	
		6"	6-0143	41.00	
		8"	6-0144	73.00	
	Male:	4"	6-0136	15.00	
		5"	6-0137	20.00	
		6"	6-0138	22.00	
		8"	6-0139	32.00	
		Full Male End:	6"	6-0135	43.00

*200-lbs. max. pressure on all sizes except 8".

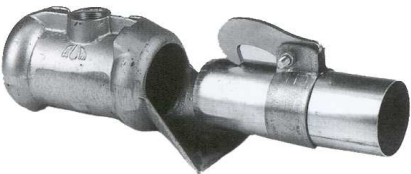
DETACHABLE COUPLER SET 	2"	6-0095	3	38.00
	3"	6-0096	4.3	49.00
	4"	6-0097	5.2	52.00
	5"	6-0098	7.6	71.00
	6"	6-0099	8.8	85.00

Includes "2" band and hook assemblies

DETACHABLE COUPLER, KNOB STYLE 	2"	6-9512	1.5	32.00
	3"	6-9513	1.9	43.00
	4"	6-9514	2.3	52.00
	5"	6-9515	3.5	66.00
	6"	6-9516	4.1	88.00
	7"	6-9517	5.8	95.00

SPIKE COUPLER

- 3/4" riser outlet
- Ideal for row crops, nurseries, or orchards
- Spike riser locks male & female coupler halves and stabilizes the riser in a vertical position
- Substantial savings over aluminum or buried solid set systems
- Improved weatherability PVC compounds
- Highest UV inhibitors.
- Highest impact resistance.
- Easy off season storage...simply remove spike riser.
- Non-corrosive aluminum tubing spike riser
- Quad seal prevents water leakage around spike.
- Slotted male end allows for up to 1-1/4" expansion and contraction of PVC pipe.
- Chevron seal gasket.



2"	6-0305	1.5	32.00
2-1/2"	6-0306	2.0	40.00

STUBBIE 	6"	6-0250	1.1	29.00
	8"	6-0251	1.5	34.00
	10"	6-0252	2.1	37.00

CENTER RISER, BOLT-ON

3"	6-0255	2.0	11.00
4"	6-0256	2.0	12.00

Has 1" Female threaded outlet.



**INDUSTRIAL GROOVE END
(STEEL & ALUM)**

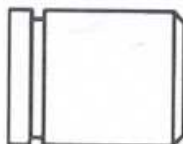

Steel			
2"	6-9721		10.20
2-1/2"	6-9722		13.00
3"	6-9723		10.90
4"	6-9724		16.80
5"	6-9725		20.00
6"	6-9726		39.00
8"	6-9727		45.00
10"	6-9728		66.00
12"	6-9729		85.00
Alum			
3"	6-9730		30.00
4"	6-9731		31.00
6"	6-9732		39.00
8"	6-9733		50.00
10"	6-9734		57.00
12"	6-9735		82.00

**INDUSTRIAL GROOVE
CLAMP**

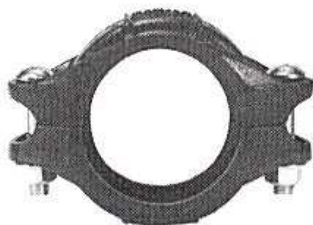

1-1/2"	9-6776	13.60
2"	6-9736	14.00
2-1/2"	6-9737	16.00
3"	6-9738	19.00
4"	6-9739	21.00
5"	6-9740	34.20
6"	6-9741	30.00
8"	6-9742	72.00
10"	6-9743	122.00
12"	6-9744	144.00

*Includes Gasket

**INDUSTRIAL GROOVE
GASKET**



1-1/2"	9-6777	7.20
2"	9-6767	7.00
2-1/2"	9-6768	8.80
3"	9-6769	9.00
4"	9-6770	13.00
5"	9-6771	20.00
6"	9-6772	22.00
8"	9-6773	34.00
10"	9-6774	32.00
12"	9-6775	36.00

*Cut-Away View

Fittings

COUPLERS & ACCESSORIES



Product	Description	Part Number	Weight	List Price
SADDLE COUPLING	3/4"	6-0100	.16	4.80
	1"	4-0011	.16	5.30

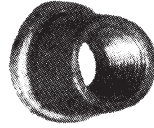

Cast Weld-on

QUICK COUPLING RISER VALVE

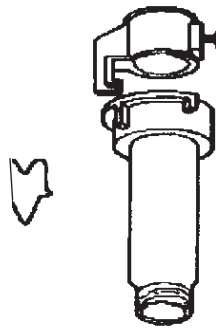

3/4" fpt x 3/4"	6-1579	.7	15.00
1"mpt x 3/4"	6-1590	.7	15.00
1"mpt x 1"	6-1591	.8	16.00

3/4" Top outlet require 1.05"ODx.113"wall SCH40 pipe; 1" require 1.315"ODx.133"wall

DEFLECTOR, FOR SPRINKLER



bolts to riser	6-1524	1.4	12.00
----------------	--------	-----	--------------

STEEL BALL/SOCKET MEASUREMENTS

Bauer Style

Ball and Socket Specs			
Size	MM	PSI	Cone of Max. Deviation
2"	50	290	30 Degrees
3"	76	290	30 Degrees
3-1/2"	89	290	30 Degrees
4"	108	175	30 Degrees
5"	133	175	20 Degrees
6"	159	175	20 Degrees
8"	194	175	20 Degrees
12"	300	175	16 Degrees

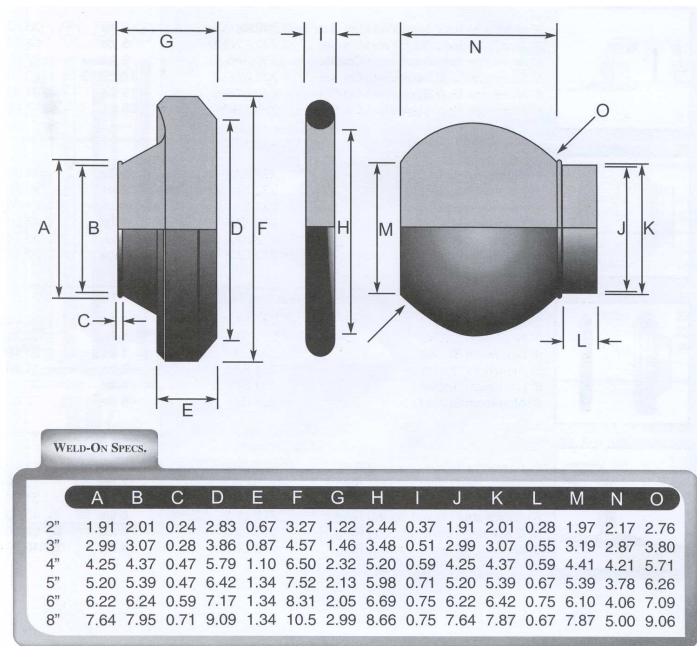

CAST ALUMINUM BALL/SOCKET MEASUREMENTS

Bauer Style

Ø	Ø	A	B	C	ØD	F	G	H	I	L
50mm	2"	2.01	2.29	2.80	3.55	1.42	2.36	1.89	2.80	2.32
76mm	3"	3.01	3.35	3.88	4.89	1.65	3.39	2.99	3.86	3.15
102mm	4"	4.02	4.41	5.67	6.70	2.21	4.37	4.22	5.67	4.41
127mm	5"	5.04	5.36	5.99	7.72	2.36	5.32	4.89	6.26	5.20
152mm	6"	6.05	6.42	7.13	8.51	2.44	6.38	5.56	7.09	5.40
203mm	8"	8.02	8.87	9.14	10.72	3.27	8.39	7.72	9.06	6.46

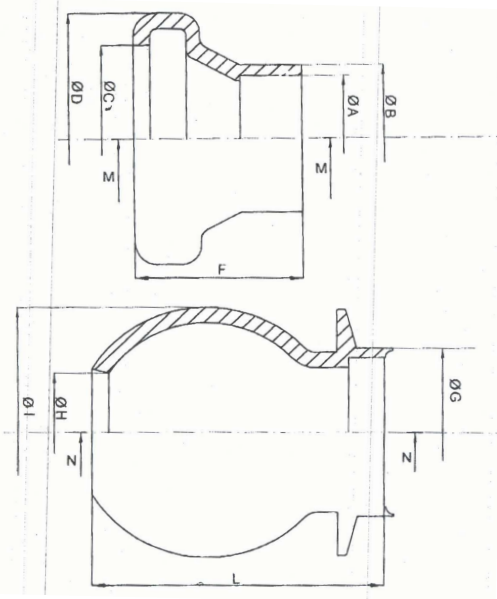

Fittings

BALL & SOCKET COUPLERS (BAUER STYLE)



Product	Description	Part Number	Weight	List Price
BLACK STEEL WELD-ON BALL/SOCKET COUPLER (BAUER STYLE)	Ball:	2" 50 1.97" 6-5000	0.3	3.30
		3" 76 3.19" 6-5001	0.6	5.00
		3-1/2" 89 3.66" 6-5002	0.8	10.50
		4" 108 4.41" 6-5003	1.1	5.80
		5" 133 5.40" 6-5005	1.8	8.50
		6" 159 6.11" 6-5006	2.8	9.00
		8" 194 7.88" 6-5007	4.2	20.00
	Socket:	2" 50 2.84" 6-5008	0.3	4.50
		3" 76 3.86" 6-5009	0.6	6.00
		3-1/2" 89 4.77" 6-5010	0.9	15.00
		4" 108 5.79" 6-5011	1.4	7.00
		5" 133 6.42" 6-5013	2.0	19.00
		6" 159 7.17" 6-5014	3.0	14.00

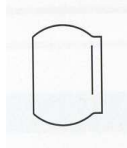

Galvanized also available.
Gasket is included with socket.
8" (194) steel will fit to 8" (203) cast aluminum.
4" (108) steel will not fit to 4" (102) cast aluminum.

CAST ALUMINUM WELD-ON BALL/SOCKET COUPLER (BAUER STYLE)	Ball:	2" 50 1.97" 6-5032	0.1	16.00
		3" 76 3.19" 6-5033	0.2	21.00
		4" 102 6-5034	0.4	21.00
		5" 127 6-5035	0.6	37.00
		6" 152 6-5036	2.15	39.00
		8" 203 6-8042		70.00

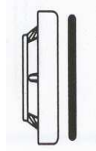
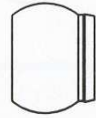

Gasket is included with socket.
5" (127) and 6" (152) alum./cast will fit to steel 5" (133) and 6" (159)

Product	Description	Part Number	Weight	List Price
STAINLESS STEEL WELD-ON BALL/SOCKET COUPLER (BAUER STYLE)	Ball:	2" 50 1.97" 9-5326	0.3	33.00
		3" 76 3.19" 9-5327	0.6	52.00
		3-1/2" 89 3.66" 9-5328	0.8	55.00
		4" 108 4.41" 9-5329	1.1	102.00
		5" 133 5.40" 9-5330	1.8	105.00
		6" 159 6.11" 9-5331	2.8	131.00
		8" 194 7.88" 9-5332	4.2	230.00
	Socket:	2" 50 2.84" 9-5333	0.3	38.00
		3" 76 3.86" 9-5334	0.6	69.00
		3-1/2" 89 4.77" 9-5335	0.9	56.00
		4" 108 5.79" 9-5336	1.4	117.00
		5" 133 6.42" 9-5337	2.0	96.00
		6" 159 7.17" 9-5338	3.0	191.00

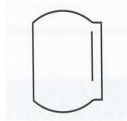

GALVANIZED LEVER (BAUER STYLE)	2" 50 2.44" 6-5024	0.9	14.00
	3" 76 3.43" 6-5025	2.4	22.00
	3-1/2" 89 4.33" 6-5026	2.6	39.00
	4" 108 5.20" 6-5027	3.2	24.00
	5" 127/133 6.20" 6-5029	6.4	42.00
	6" 152/159 7.20" 6-5030	8.7	55.00
	8" 194/203 9.25" 6-5031	12.3	92.00
	(3-Hooks) 8" 203 6-5084	13.0	150.00
	12" 300 9-5818		245.00



*specify black or galvanized
*133 and 159 will fit to alum. and cast 127 and 152

**SEALING RING GASKET
(BAUER STYLE)**



2"	50	6-5016	--	1.10
3"	76	6-5017	--	1.90
3-1/2"	89	6-5018	--	5.00
4"	108	6-5019	--	3.10
5"	127 / 133	6-5021	--	5.20
6"	152 / 159	6-5022	--	5.30
8"	194	6-5023	--	7.00
8"	203	6-5080	--	10.00
12"	300	9-5819		21.00

SAFETY PINS, LEVER



2"	50	9-5810		2.50
3"	76	9-5811		2.50
4"	108	9-5812		3.75
6"	159	9-5813		3.75
8"	194	9-5814		3.75

**GALVANIZED STEEL
HOSE BARB X MALE
BALL (BAUER STYLE)**

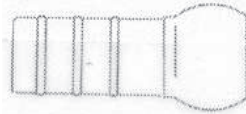

Galvanized

2"	50	3-0684	0.8	14.00
3"	76	3-0685	1.8	20.00
4"	108	3-0686	3.7	32.00
5"	133	3-0688	5.0	48.00
6"	159	3-0689	7.4	45.00
8"	194	3-0690	8.6	95.00

**GALVANIZED STEEL
HOSE BARB X FEMALE
SOCKET (BAUER STYLE)**

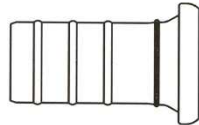

Galvanized
Gasket is included with sock

2"	50	3-0691	0.9	19.00
3"	76	3-0692	1.8	33.00
4"	108	3-0693	3.1	40.00
5"	133	3-0695	5.3	45.00
6"	159	3-0696	7.3	50.00
8"	194	3-0697	9.5	105.00

**STAINLESS STEEL
HOSE BARB X MALE
BALL (BAUER STYLE)**

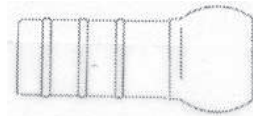

Stainless Steel

2"	50	9-5340	0.8	73.00
3"	76	9-5341	1.8	105.00
4"	108	9-5342	3.7	200.00
6"	159	9-5343	7.4	238.00
8"	194	9-5344	8.6	448.00

Fittings

**STAINLESS STEEL
HOSE BARB X FEMALE
SOCKET (BAUER STYLE)**

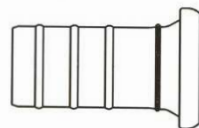

Stainless Steel
Gasket is included with socket

2"	50	9-5345	0.9	80.00
3"	76	9-5346	1.8	124.00
4"	108	9-5347	3.1	244.00
6"	159	9-5348	7.3	327.00
8"	194	9-5349	9.5	525.00