

BALL & SOCKET FITTINGS (BAUER STYLE)

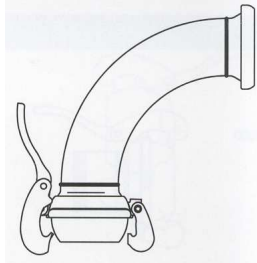

Product	Description	Part Number	Weight	List Price
ELBOW, 90 DEGREE	2" 50	6-9038	--	82.00
	3" 76	6-9039	--	97.00
	3-1/2" 89	6-9040	--	122.00
	4" 108	6-9041	--	113.00
	5" 133	6-9042	--	152.00
	6" 159	6-9043	--	172.00
	8" 194	6-9044	--	295.00



Gasket is included with socket
-Steel Galvanized

ELBOW, 45 DEGREE	2" 50	6-9045	--	85.00
	3" 76	6-9046	--	110.00
	3-1/2" 89	6-9047	--	165.00
	4" 108	6-9048	--	140.00
	5" 133	6-9049	--	142.00
	6" 159	6-9050	--	158.00
	8" 194	6-9051	--	269.00



Gasket is included with socket
-Steel Galvanized

LINE TEE	2" 50	6-9052	--	140.00
	3" 76	6-9053	--	190.00
	3-1/2" 89	6-9054	--	190.00
	4" 108	6-9055	--	165.00
	5" 133	6-9056	--	199.00
	6" 159	6-9057	--	225.00
	8" 194	6-9058	--	330.00

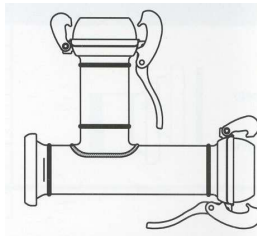

Gasket is included with socket
-Steel Galvanized

END TEE	2" 50	6-9059	--	139.00
	3" 76	6-9060	--	140.00
	3-1/2" 89	6-9061	--	185.00
	4" 108	6-9062	--	165.00
	5" 133	6-9063	--	195.00
	6" 159	6-9064	--	225.00
	8" 194	6-9065	--	331.00



Gasket is included with socket
-Steel Galvanized

FOOT VALVE, BALL/LEVER	2" 50	6-9066	--	105.00
	3" 76	6-9067	--	215.00
	3-1/2" 89	6-9068	--	225.00
	4" 108	6-9069	--	278.00
	5" 133	6-9070	--	379.00
	6" 159	6-9071	--	489.00
	8" 194	6-9072	--	875.00



-Steel Galvanized

MALE PLUG (BAUER STYLE)

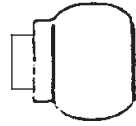

See previous page for lever.

		<u>MM</u>			
	2"	50	6-9024	--	63.00
	3"	76	6-9025	--	66.00
	3-1/2"	89	6-9026	--	69.00
	4"	108	6-9027	--	71.00
	5"	133	6-9028	--	76.00
	6"	159	6-9029	--	75.00
	8"	194	6-9030	--	92.00

**ADAPTER, MALE
THREAD X BALL (BAUER STYLE)**

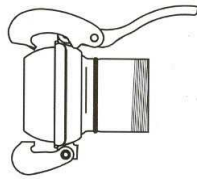

The lever is included with fitting.

	2"	50	6-9010	--	69.00
	3"	76	6-9011	--	79.00
	3-1/2"	89	6-9012	--	112.00
	4"	108	6-9013	--	89.00
	5"	133	6-9014	--	123.00
	6"	159	6-9015	--	126.00
	8"	194	6-9016	--	230.00

**ADAPTER, MALE
THREAD X SOCKET
(BAUER STYLE)**

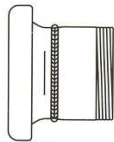

Gasket is included with socket

	2"	50	6-9017	--	57.00
	3"	76	6-9018	--	57.00
	3-1/2"	89	6-9019	--	75.00
	4"	108	6-9020	--	65.00
	5"	133	6-9021	--	89.00
	6"	159	6-9022	--	90.00
	8"	194	6-9023	--	160.00

BALL & SOCKET COUPLERS (100/200 STYLE)



Product	Description	Part Number	Weight	List Price	
BLACK STEEL WELD-ON BALL/SOCKET COUPLER (100/200 STYLE) (PBCI, "BETTER-BILT®")	Ball w/loose Ring				
	4" (100 mm)	100 series 6-5044	2.0	10.00	
	6" (150mm)	100 series 6-5045	4.7	22.00	
	8" (200 mm)	200 series 6-5050	11.3	39.00	
	10" (250 mm)	200 series 6-5051	17.8	69.00	
	12" (300 mm)	200 series 6-5052	30.8	129.00	
	Socket w/lever attached	Gasket is included with socket.			
	4" (100 mm)	100 series 6-5046	2.6	11.00	
	6" (150 mm)	100 series 6-5047	4.1	26.00	
	8" (200 mm)	200 series 6-5053	10.8	57.00	
	10" (250 mm)	200 series 6-5054	14.0	87.00	
	12" (300 mm)	200 series 6-5055	31.9	182.00	
	Sealing Ring Gasket				
	4" (100 mm)	100 series 6-5048	--	2.00	
	6" (150 mm)	100 series 6-5049	--	3.00	
8" (200 mm)	200 series 6-5056	--	10.00		
10" (250 mm)	200 series 6-5057	--	11.00		
12" (300 mm)	200 series 6-5058	--	13.00		

Italian 100/200 Ball and Socket Specs			
Size	MM	PSI	Cone of Max. Deviation
4"	100	115	28 Degrees
6"	150	87	22 Degrees
8"	200	116	28 Degrees
10"	250	72	16 Degrees
12"	300	58	16 Degrees

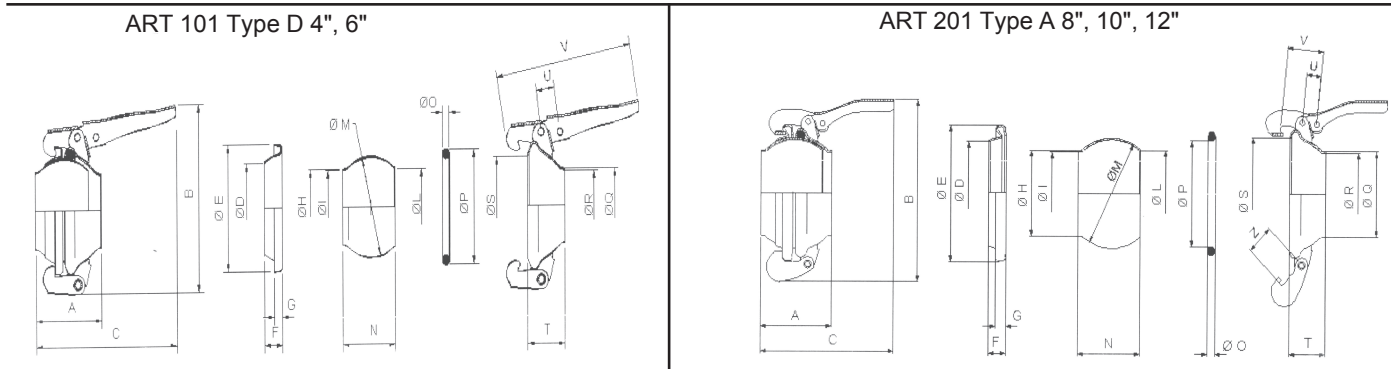

ART 101 Type D 4", 6"
ART 201 Type A 8", 10", 12"

Ø	Ø	A	B	C	Ø D	Ø F	F	G	Ø H	Ø I	Ø I	Ø M	N
100	4"	4.89	8.67	9.46	4.65	6.30	1.18	0.51	3.78	3.66	3.94	5.08	3.51

Ø O	Ø P	Ø Q	Ø R	Ø S	T	U	V
0.46	4.85	3.78	3.62	5.16	2.40	1.14	2.48

Ø	Ø	A	B	C	Ø D	Ø F	F	G	Ø H	Ø I	Ø I	Ø M	N
150	6"	5.79	11.43	10.64	6.90	9.10	1.38	0.83	5.71	5.52	5.83	7.33	4.81
200	8"	6.70	14.18	15.37	8.67	11.43	1.85	1.10	8.12	7.80	7.64	9.53	5.40

Ø O	Ø P	Ø Q	Ø R	Ø S	T	U	V	Z
0.57	7.11	5.67	5.44	7.41	2.80	1.10	3.55	2.09
0.73	9.22	8.12	7.80	9.57	3.86	1.38	4.06	2.36

**HOSE BARB X BALL/RING
(100/200 STYLE)**

4" (100 mm)	100 series	6-9073	--	66.00
6" (150 mm)	100 series	6-9074	--	64.00
8" (200 mm)	200 series	6-9075	--	109.00
10" (250 mm)	200 series	6-9076	--	135.00
12" (300 mm)	200 series	6-9077	--	225.00

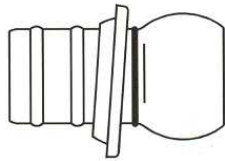

**HOSE BARB X SOCKET
(100/200 STYLE)**

4" (100 mm)	100 series	6-9078	--	69.00
6" (150 mm)	100 series	6-9079	--	61.00
8" (200 mm)	200 series	6-9080	--	114.00
10" (250 mm)	200 series	6-9081	--	142.00
12" (300 mm)	200 series	6-9082	--	265.00

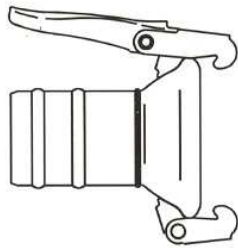

**ELBOW, 90
(100/200 STYLE)**

4" (100 mm)	100 series	6-9083	--	88.00
6" (150 mm)	100 series	6-9084	--	130.00
8" (200 mm)	200 series	6-9085	--	225.00
10" (250 mm)	200 series	6-9086	--	274.00
12" (300 mm)	200 series	6-9087	--	380.00

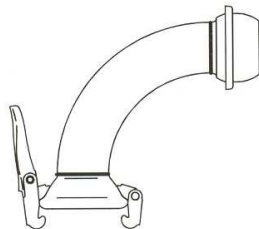

**ELBOW, 45
(100/200 STYLE)**

4" (100 mm)	100 series	6-9088	--	125.00
6" (150 mm)	100 series	6-9089	--	120.00
8" (200 mm)	200 series	6-9090	--	182.00
10" (250 mm)	200 series	6-9091	--	220.00
12" (300 mm)	200 series	6-9092	--	330.00



Fittings

CAM-LOC FITTINGS



Product	Description	Part Number	Weight	List Price
---------	-------------	-------------	--------	------------

FEMALE THREAD X MALE CAM-LOC

(Cast Aluminum)

"A" series

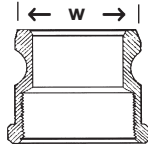

Width				
1/2"		9-5889	--	3.50
3/4"		9-5890	--	3.50
1"		9-5891	--	3.50
1-1/4"		9-5892	--	4.00
1-1/2"		9-5893	--	4.50
2"	2-1/2"	6-6918	--	5.00
2-1/2"	3"	6-6919	--	7.20
3"	3-5/8"	6-6920	--	10.00
4"	4-3/4"	6-6921	--	17.00
5"	5-3/4"	6-6922	--	27.00
6"	6-15/16"	6-6923	--	33.00
8"		6-6897	--	83.00

FEMALE THREAD X FEMALE CAM-LOC

(Cast Aluminum)

"D" series

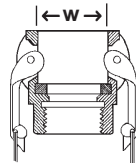

1/2"		9-5904	--	6.50
3/4"		9-5905	--	6.50
1"		9-5906	--	7.50
1-1/4"		9-5907	--	9.50
1-1/2"		9-5908	--	9.50
2"	2-1/2"	6-6924	--	10.00
2-1/2"	3"	6-6925	--	15.00
3"	3-5/8"	6-6926	--	17.00
4"	4-3/4"	6-6927	--	25.00
5"	5-3/4"	6-6928	--	40.00
6"	6-15/16"	6-6929	--	56.00
8"		6-9788	--	205.00

MALE THREAD X MALE CAM-LOC

(Cast Aluminum)

"F" series

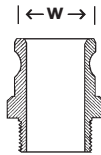

1/2"		9-5914	--	3.50
3/4"		9-5915	--	3.50
1"		9-5916	--	4.00
1-1/4"		9-5917	--	4.80
1-1/2"		9-5918	--	5.00
2"	2-1/2"	6-6930	--	6.00
2-1/2"	3"	6-6931	--	11.00
3"	3-5/8"	6-6932	--	12.00
4"	4-3/4"	6-6933	--	22.70
5"	5-3/4"	6-6934	--	37.00
6"	6-15/16"	6-6935	--	42.00

MALE THREAD X FEMALE CAM-LOC

(Cast Aluminum)

"B" series

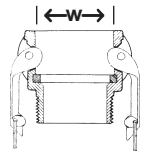

1/2"		9-5894	--	6.50
3/4"		9-5895	--	6.50
1"		9-5896	--	7.50
1-1/4"		9-5897	--	9.50
1-1/2"		9-5898	--	9.50
2"	2-1/2"	6-6936	--	10.00
2-1/2"	3"	6-6937	--	14.00
3"	3-5/8"	6-6938	--	17.00
4"	4-3/4"	6-6939	--	26.00
5"	5-3/4"	6-6940	--	48.00
6"	6-15/16"	6-6941	--	59.00

CAMLOC FITTINGS

Working Pressure	
Size	MAX. (PSI)
1/2" through 2"	250
2 1/2" through 4"	150
5" through 6"	75
8" through 12"	50

**HOSE BARB X MALE
CAM-LOC**

(Cast Aluminum)

"E"

series

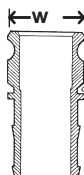

1/2"		9-5909	--	3.50
3/4"		9-5910	--	3.50
1"		9-5911	--	4.00
1-1/4"		9-5912	--	4.50
1-1/2"		9-5913	--	5.00
2"	2-1/2"	6-6900	--	6.00
2-1/2"	3"	6-6901	--	10.00
3"	3-5/8"	6-6902	--	12.00
4"	4-3/4"	6-6903	--	22.00
5"	5-3/4"	6-6914	--	30.00
6"	6-15/16"	6-6915	--	44.00
8"		6-6899	--	111.00

**HOSE BARB X FEMALE
CAM-LOC**

(Cast Aluminum)

"C"

series

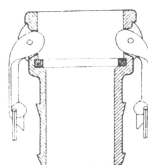

1/2"		9-5899	--	6.50
3/4"		9-5900	--	6.50
1"		9-5901	--	7.50
1-1/4"		9-5902	--	9.50
1-1/2"		9-5903	--	9.50
2"	2-1/2"	6-6904	--	10.00
2-1/2"	3"	6-6905	--	15.00
3"	3-5/8"	6-6906	--	18.00
4"	4-3/4"	6-6907	--	24.00
5"	5-3/4"	6-6916	--	42.00
6"	6-15/16"	6-6917	--	58.00
8"		6-6898	--	159.00

**GASKET,
CAM-LOC**



	OD	ID		
1/2"			9-6748	.50
3/4"			9-6749	2.60
1"			9-6750	.50
1-1/4"			9-6751	.50
1-1/2"			9-6752	.50
2"	2-5/8"	2"	6-6908	.50
2-1/2"	3-1/8"	2-3/8"	6-6909	.60
3"	3-25/32"	3"	6-6910	.70
4"	4-7/8"	4"	6-6911	.90
5"	5-29/32"	4-7/8"	6-6912	3.00
6"	7-1/16"	6"	6-6913	3.00
8"			9-5876	10.50

**END CAP (DUST CAP)
CAM-LOC**

(Cast Aluminum)

"V"

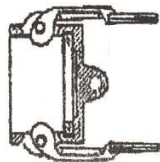

1/2"		9-5919	--	5.00
3/4"		9-5920	--	5.50
1"		9-5921	--	6.50
1-1/4"		9-5922	--	8.50
1-1/2"		9-5923	--	8.00
2"	2-1/2"	9-5924	--	8.00
2-1/2"	3"	9-5925	--	10.50
3"	3-5/8"	9-5926	--	12.50
4"	4-3/4"	9-5927	--	17.50
5"	5-3/4"	9-5928	--	42.00
6"	6-15/16"	9-5929	--	43.00
8"		9-6832	--	163.00

**END PLUG (DUST PLUG)
CAM-LOC**

(Cast Aluminum)

"W"



1/2"		9-5930	--	3.00
3/4"		9-5931	--	3.00
1"		9-5932	--	3.00
1-1/4"		9-5933	--	3.50
1-1/2"		9-5934	--	3.50
2"	2-1/2"	9-5935	--	4.00
2-1/2"	3"	9-5936	--	7.00
3"	3-5/8"	9-5937	--	7.00
4"	4-3/4"	9-5938	--	12.50
5"	5-3/4"	9-5939	--	21.50
6"	6-15/16"	9-5940	--	28.00

*Note: Plastic, Stainless Steel, and Brass Cam-Loc Fittings available, please call.

*Note: Cam-Loc fittings can also be used for fast & easy suction fittings.

* Please note: 5" & 8" mfg. by different companies may not interchange.

ELBOWS

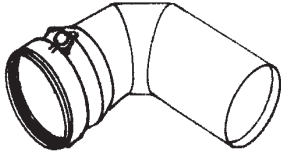

Product	Description	Part Number	Weight	List Price
ALUMINUM, PLAIN 	2" x 45°	6-0354	2.0	55.00
	3" x 45°	6-0355	2.0	60.00
	4" x 45°	6-0350	2.0	60.00
	5" x 45°	6-0356	2.5	70.00
	6" x 45°	6-0351	3.0	79.00
	8" x 45°	6-0352	6.0	79.00
	10" x 45°	6-0353	8.0	91.00
	12" x 45°	6-9001		242.00
	2" x 90°	6-0364	2.0	65.00
	3" x 90°	6-0365	2.0	80.00
	4" x 90°	6-0360	2.0	80.00
	5" x 90°	6-0366	2.5	85.00
	6" x 90°	6-0361	4.0	85.00
	8" x 90°	6-0362	7.0	95.00
	10" x 90°	6-0363	10.0	109.00
	12" x 90°	6-8021		285.00



GALVANIZED STEEL, RINGLOCK 	6" x 45°	6-0310	11.0	84.00
	8" x 45°	6-0311	18.5	107.00
	10" x 45°	6-0312	22.5	145.00
	6" x 90°	6-0320	13.0	99.00
	8" x 90°	6-0321	20.5	135.00
	10" x 90°	6-0322	25.5	179.00

Ringlock clamp is not included.

GALVANIZED STEEL, M X M RINGLOCK  Double Male Ring Lock	6" x 90°	9-5350	13.0	99.00
	8" x 90°	9-5351	20.5	135.00
	10" x 90°	9-5352	25.5	179.00

CAST ALUMINUM RINGLOCK 	6" x 45°	6-0370	5.0	116.00
	8" x 45°	6-0371	8.0	143.00
	10" x 45°	6-0372	10.0	185.00
	6" x 90°	6-0380	5.0	144.00
	8" x 90°	6-0381	8.0	175.00
	10" x 90°	6-0382	10.0	245.00

Ringlock clamp is not included.

PVC, SURFACE   	6" x 22.5°	6-0330	--	59.00
	8" x 22.5°	6-0331	--	68.00
	10" x 22.5°	6-0332	--	87.00
	12" x 22.5°	6-0333	--	111.00
	6" x 45°	6-0340	--	57.00
	8" x 45°	6-0341	--	68.00
	10" x 45°	6-0342	--	87.00
	12" x 45°	6-0343	--	110.00
	6" x 90°	6-0344	--	64.00
	8" x 90°	6-0345	--	81.00
	10" x 90°	6-0346	--	110.00
	12" x 90°	6-0347	--	140.00

CAST ALUMINUM, HOOK



2" x 45°	6-0390	2.3	52.00
3" x 45°	6-0391	2.9	65.00
4" x 45°	6-0392	4.2	77.00
2" x 90°	6-0395	2.5	48.00
3" x 90°	6-0396	2.8	62.00
4" x 90°	6-0397	4.4	79.00

CAST ALUMINUM, TWIST-LOCK



6" x 45°	6-0313	--	141.00
6" x 90°	6-0314	--	173.00

*Call for other twist-lock sizes

CAST ALUMINUM, KNOB

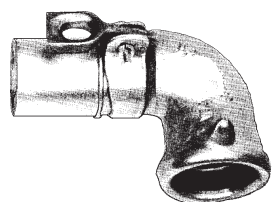

2" x 45°	6-0403	--	71.00
3" x 45°	6-0404	--	86.00
4" x 45°	6-0405	--	109.00
5" x 45°	6-0406	--	129.00
6" x 45°	6-0407	--	153.00
2" x 90°	6-0398	--	52.00
3" x 90°	6-0399	--	66.00
4" x 90°	6-0400	--	89.00
5" x 90°	6-0401	--	126.00
6" x 90°	6-0402	--	154.00

CAST ALUMINUM, WELD-ON

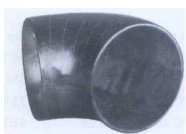
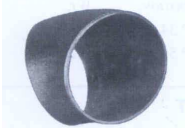

3" x 45°	6-0270	--	25.00
4" x 45°	6-0271	--	26.00
5" x 45°	6-9943	--	35.00
6" x 45°	6-0272	--	44.00
8" x 45°	6-0273	--	53.00
10" x 45°	6-0274	--	77.00
3" x 90°	6-0275	--	42.00
4" x 90°	6-0276	--	45.00
5" x 90°	6-9942	--	58.00
6" x 90°	6-0277	--	71.00
8" x 90°	6-0278	--	85.00
10" x 90°	6-0279	--	130.00

BLACK STEEL, SWEEPING WELD-ON

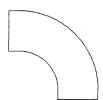

2" x 45°	6-0075	2.0	10.00
3" x 45°	6-0076	4.0	29.00
4" x 45°	6-0077	5.5	45.00
6" x 45°	6-0078	10.0	52.00
8" x 45°	9-6813	15.0	59.00
2" x 90°	6-0001	2.0	16.00
3" x 90°	6-0002	4.0	22.00
4" x 90°	6-0003	6.0	33.00
5" x 90°	9-5017	--	57.00
6" x 90°	6-0004	12.0	62.00
8" x 90°	6-9939	36.0	69.00

BLACK STEEL, WELD-ON

-10 gauge
-Measurements:
45 deg 3"x3" extensions
90 deg 3"x2"x3"

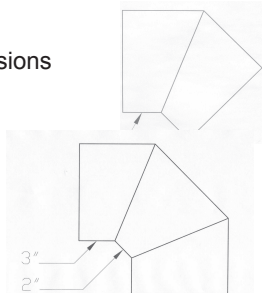

3" x 45°	6-0280	3.0	34.00
4" x 45°	6-0281	5.0	38.00
6" x 45°	6-0282	9.0	45.00
8" x 45°	6-0283	11.0	55.00
10" x 45°	6-0268	13.0	65.00
12" x 45°	6-0269	15.0	70.00
3" x 90°	6-0284	4.0	45.00
4" x 90°	6-0285	6.0	49.00
6" x 90°	6-0286	10.0	75.00
8" x 90°	6-0287	12.0	89.00
10" x 90°	6-0288	15.0	112.00
12" x 90°	6-0289	20.0	125.00

Fittings

END TEES



Product	Description	Part Number	Weight	List Price
FLANGED ELBOW, STEEL GALV.	6"	9-5825	--	165.00
	8"	9-5826	--	180.00
	10"	9-5827	--	225.00

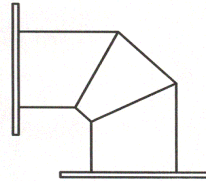

Also Available in Cast Aluminum, call for prices.

ALUMINUM, PLAIN



2"	6-0444	4.0	81.00
3"	6-0445	5.0	81.00
4"	6-0440	6.0	90.00
5"	6-0446	7.0	110.00
6"	6-0441	8.0	130.00
8"	6-0442	11.5	155.00
10"	6-0443	15.0	195.00
12"	6-8026		512.00

GALVANIZED STEEL, RINGLOCK

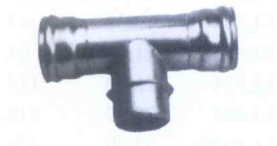

6"	6-0410	19.0	105.00
8"	6-0411	33.0	145.00
10"	6-0412	44.0	232.00

Ringlock clamp is not included. See page 67.

CAST ALUMINUM, RINGLOCK

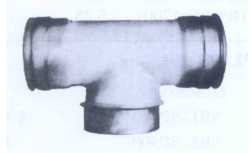

6"	6-0430	10.0	189.00
8"	6-0431	13.0	249.00
10"	6-0432	18.0	295.00

Ringlock clamp is not included. See page 67.

CAST ALUMINUM, HOOK



2"	6-0450	2.9	71.00
3"	6-0451	4.3	81.00
4"	6-0452	5.3	145.00

ALUMINUM, TWIST-LOCK

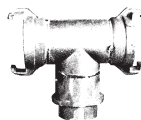

6"	6-0316	--	191.00
----	--------	----	---------------

ALUMINUM, KNOB

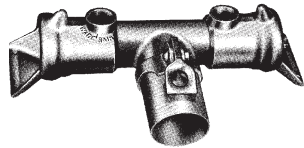

2"	6-0460	--	82.00
3"	6-0461	--	90.00
4"	6-0462	--	102.00
*5"	6-0463	--	170.00
*6"	6-0464	--	188.00

* Fabricated Aluminum.

PVC, SURFACE

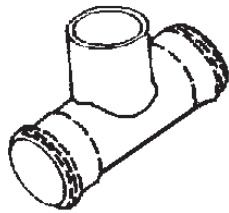

6"	6-0447	--	81.00
8"	6-0448	--	102.00
10"	6-0449	--	120.00
12"	6-0453	--	169.00

TEE, FLANGED, STEEL GALVANIZED

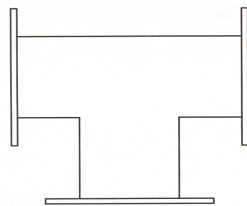

6"	9-5822		205.00
8"	9-5823		259.00
10"	9-5824		349.00

Also Available in Cast Aluminum, call for prices.

CAST ALUMINUM, WELD-ON



4"	6-9940	2.0	63.00
5"	6-9941	2.5	69.00
6"	6-0290	3.0	79.00
8"	6-0291	5.8	109.00
10"	6-0292	8.0	131.00

BLACK STEEL, WELD-ON

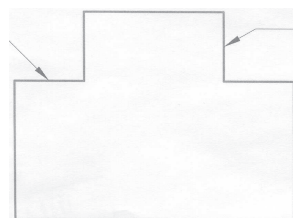

4"	6-0293	4.5	49.00
5"	6-0294	6.0	52.00
6"	6-0295	7.4	60.00
8"	6-0296	15.0	73.00
10"	6-0297	19.8	89.00
12"	6-0298	34.8	102.00

Fittings

-10 gauge
-Measurements:
4"x4" extensions

LINE TEES & Y TEES

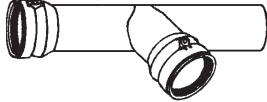

Product	Description	Part Number	Weight	List Price
LINE TEE, ALUMINUM PLAIN 	2"	6-0644	3.0	81.00
	3"	6-0645	3.0	81.00
	4"	6-0640	4.3	90.00
	5"	6-0646	4.5	110.00
	6"	6-0641	5.0	130.00
	8"	6-0642	12.0	155.00
	10"	6-0643	14.5	195.00
	12"	6-8025		512.00

LINE TEE, GALVANIZED STEEL RINGLOCK 	6"	6-0610	14.0	105.00
	8"	6-0611	33.0	145.00
	10"	6-0612	44.0	232.00

Ringlock clamp is not included.

LINE TEE, CAST ALUMINUM RINGLOCK 	6"	6-0630	10.0	189.00
	8"	6-0631	13.0	249.00
	10"	6-0632	18.0	295.00

Ringlock clamp is not included.

LINE TEE, PVC SURFACE 	6"	6-0647	--	81.00
	8"	6-0648	--	101.00
	10"	6-0649	--	126.00
	12"	6-0653	--	172.00

LINE TEE, ALUMINUM TWIST-LOCK 	6"	6-0317	--	191.00
---	----	--------	----	---------------

LINE TEE, CAST ALUMI-NUM HOOK 	2"	6-0650	2.2	79.00
	3"	6-0651	4.6	95.00
	4"	6-0652	6.2	125.00

LINE TEE, CAST ALUMINUM KNOB



2"	6-0660	--	82.00
3"	6-0661	--	90.00
4"	6-0662	--	102.00
5"	6-0663	--	170.00
6"	6-0664	--	188.00

LINE Y TEE, ALUMINUM PLAIN

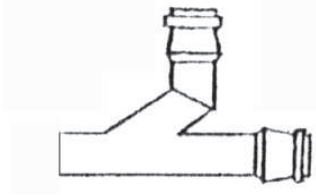

6"	6-0550		145.00
8"	6-0551		175.00
10"	6-0552		195.00

Y TEE, ALUMINUM PLAIN

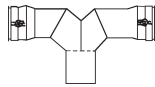

6"	6-0540	7.0	125.00
8"	6-0541	9.0	139.00
10"	6-0542	11.0	169.00
12"	6-8027		465.00

Y TEE, STEEL RINGLOCK

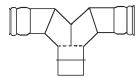

6"	6-0510	19.0	239.00
8"	6-0511	22.0	259.00
10"	6-0512	25.0	299.00

Ringlock clamp is not included.

Y TEE, ALUMINUM RINGLOCK

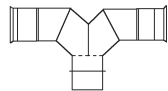

6"	6-0530	8.0	219.00
8"	6-0531	10.0	229.00
10"	6-0532	12.0	289.00

Ringlock clamp is not included.

Fittings

REDUCERS



Product	Description	Part Number	Weight	List Price
REDUCER, ALUMINUM PLAIN	3" x 2"	6-0614	2.0	44.00
	4" x 3"	6-0615	2.5	44.00
	5" x 4"	8-1428	3.0	69.00
	6" x 4"	6-0710	3.0	54.00
	8" x 4"	6-0713	4.0	91.00
	8" x 6"	6-0711	3.0	54.00
	10" x 8"	6-0712	4.0	67.00
	12" x 10"	6-9002		115.00

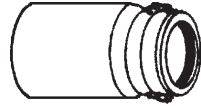

REDUCER, GALVANIZED STEEL RINGLOCK	6" x 4"	6-0730	7.0	68.00
	8" x 4"	6-0733	10.0	159.00
	8" x 6"	6-0731	10.3	72.00
	10" x 8"	6-0732	17.8	95.00

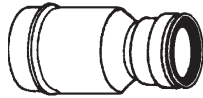

REDUCER, CAST ALUMINUM HOOK	3" x 2"	6-0720	3.0	49.00
	4" x 3"	6-0721	2.3	52.00



REDUCER, CAST ALUMINUM KNOB	3" x 2"	6-0717	--	74.00
	4" x 3"	6-0718	--	90.00
	5" x 4"	6-0719	--	110.00
	6" x 4"	6-0709	--	120.00

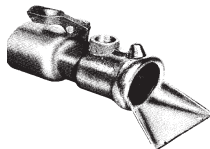

REDUCERS & INCREASERS

REDUCER, PVC SURFACE

8" x 6"	6-0714	--	49.00
10" x 8"	6-0715	--	57.00
12" x 10"	6-0716	--	69.00



INCREASER, ALUMINUM PLAIN

4" x 6"	6-0740	4.0	68.00
6" x 8"	6-0741	6.0	75.00
8" x 10"	6-0742	8.0	115.00
10" x 12"	6-9003		246.00

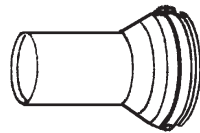

INCREASER, GALVANIZED STEEL RINGLOCK

6" x 8"	6-0760	10.0	69.00
8" x 10"	6-0761	12.0	75.00

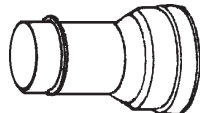

INCREASER, PVC SURFACE

6" x 8"	6-0743	--	46.00
8" x 10"	6-0744	--	54.00
10" x 12"	6-0745	--	67.00



Fittings

END PLUGS



Product	Description	Part Number	Weight	List Price
END PLUG, ALUMINUM PLAIN	4"	6-0810	1.0	29.00
	5"	6-0814	1.5	24.00
	6"	6-0811	1.5	32.00
	8"	6-0812	2.0	36.00
	10"	6-0813	2.0	39.00
	12"	6-8020		88.00



END PLUG, GALVANIZED STEEL RINGLOCK	6"	6-0830	5.0	35.00
	8"	6-0831	8.0	46.00
	10"	6-0832	14.0	69.00

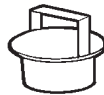

Ringlock clamp is not included. See page 67.

END PLUG, CAST ALUMINUM, HOOK	2"	6-0821	0.7	21.00
	3"	6-0822	1.0	18.00
	4"	6-0820	1.7	35.00
	5"	6-0823	2.3	46.00
	6"	6-0824	2.7	49.00



END PLUG, ALUMINUM TWIST-LOCK	6"	6-0315	--	69.00
--------------------------------------	----	--------	----	--------------



**END PLUG, CAST ALUMINUM
KNOB**

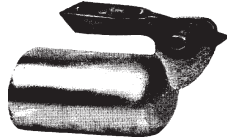

2"	6-0833	0.7	23.00
3"	6-0834	1.0	24.00
4"	6-0835	1.7	30.00
5"	6-0836	2.3	39.00
6"	6-0837	2.7	44.00

END PLUG, PVC SURFACE



6"	6-0815	--	22.00
8"	6-0816	--	26.00
10"	6-0817	--	32.00
12"	6-0818	--	41.00

**END CAP, STEEL
RINGLOCK**

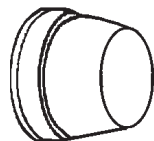

6"	6-0870	5.0	69.00
8"	6-0871	8.5	73.00

Ringlock clamp is not included. See page 67.

**END CAP, STEEL W/LOCKING
BLOCKS**

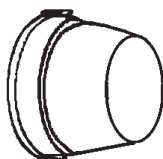

6"	6-0880	5.0	72.00
8"	6-0881	8.5	76.00

Fittings